

SITRANS MAG 3100 / 3100HT / 3100P / 5100W

Quick Start

- Ⓔ Electromagnetic flowmeter
- Ⓓ Magnetisch-induktiver Durchflußmessgerät
- Ⓕ Débitmètre électromagnétique
- Ⓔ Transmisor de agua electromagnético
- Ⓓ Medidor de vazão electromagnético



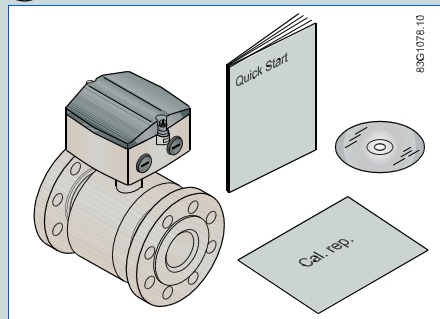

- Ⓔ Items supplied
- Ⓔ Ítems suministrados
- Ⓓ Lieferumfang
- Ⓓ Itens Fornecidos
- Ⓕ Pièces fournies

MAG 3100 / 3100HT / 3100P

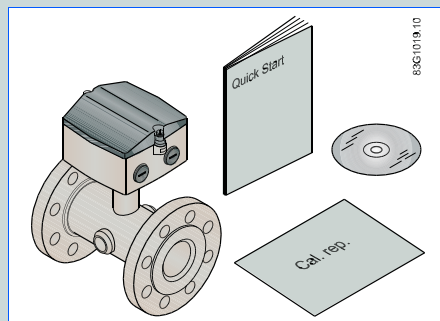

MAG 5100W



- Ⓔ  For more information see the operating instructions on the enclosed CD-ROM.
- Ⓓ  Weitere Informationen siehe Betriebsanleitung auf der beigefügten CD-ROM.
- Ⓕ  Pour plus de détail consulter les instructions d'utilisation sur le CD-ROM fourni.
- Ⓔ  Para más información ver las instrucciones de servicio en el CD-ROM.
- Ⓓ  Para mais informações, consulte as instruções de funcionamento no CD-ROM anexo.

SITRANS F

SIEMENS

(EN) General instructions

Before installing, including in hazardous areas, refer to the operating instructions on the enclosed CD-ROM. It contains detailed safety regulations, information and specifications which must be observed when installing. Changes can occur. Documentations and approvals can be found on the Internet at www.siemens.com/flowdocumentation.

⚠ Caution!

Correct, reliable operation of the product requires proper transport, storage, positioning and assembly as well as careful operation and maintenance. Only qualified personnel should install or operate this instrument.

(DE) Allgemeine Hinweise

Vor der Installation, einschließlich in Gefahrenbereichen, lesen Sie die Betriebsanleitung auf der beigefügten CD-ROM. Sie enthält die Sicherheitsvorschriften, Hinweise und technischen Daten, die bei der Installation zu beachten sind. Änderungen sind vorbehalten. Dokumentationen und Zulassungen finden Sie im Internet unter www.siemens.com/flowdocumentation.

⚠ Vorsicht!

Damit dieses Produkt zuverlässig funktioniert, muss es sachgemäß transportiert, aufbewahrt, positioniert und montiert werden. Es muss mit Sorgfalt betrieben und gewartet werden. Nur entsprechend qualifiziertes Personal darf dieses Produkt installieren und betreiben.

(FR) Instructions générales

Avant l'installation, y compris en zone dangereuse, veuillez consulter les consignes de sécurité, les informations et les spécifications dans les instructions de service (Instructions) correspondant, disponible sur le CD fourni. Des modifications pouvant être apportées, vous trouverez l'ensemble des documents et agréments mis à jours sur internet à l'adresse www.siemens.com/flowdocumentation.

⚠ Prudence!

Le fonctionnement fiable et sécuritaire du produit implique le respect des consignes de transport, de stockage, de montage et de mise en service ainsi qu'une utilisation et maintenance soigneuses. Seul le personnel qualifié doit installer ou utiliser l'instrument.

(ES) Instrucciones generales

Antes de instalar el aparato (incluso en entornos peligrosos), consultar las normas de seguridad, las especificaciones y los datos técnicos proporcionados en los instrucciones de servicio incluido en el CD Sujeto a cambios sin previo aviso. La documentación y las aprobaciones están disponibles en internet: www.siemens.com/flowdocumentation.

⚠ ¡Precaución!

El funcionamiento correcto y fiable del producto requiere un transporte, almacenamiento, colocación y montaje adecuados así como una utilización y mantenimiento cuidadosos. Este instrumento sólo debe ser instalado y utilizado por personal calificado.

(PT) Instruções Gerais

Antes de efectuar a instalação incluindo em áreas classificadas, consulte as instruções de funcionamento no CD-ROM anexo. Este contém regulamentos de segurança, informações e especificações detalhadas que devem ser tidas em consideração aquando da instalação. Podem ocorrer alterações. A Documentação e as aprovações podem ser encontradas no sítio web www.siemens.com/flowdocumentation.

⚠ Cuidado!

O funcionamento correcto e confiável do produto depende do transporte, armazenamento, posicionamento e montagem apropriados. O produto deve ser utilizado e mantido cuidadosamente. Apenas pessoal qualificado deve instalar ou utilizar este instrumento.

EN Safety instructions

⚠ For safety reasons it is important that the following points are read and understood before the installation of the equipment:

- Installation, connection, commissioning and service must be carried out by personnel qualified and authorized to do so.
- It is the responsibility of the customer that the instructions and directions provided in the Quick Start and in the operating instructions on the enclosed CD-ROM are read, understood and followed by the relevant personnel before installing the equipment.
- It is the responsibility of the customer to instruct and authorize personnel to operate the equipment.
- It is the responsibility of the customer to ensure that the measuring system is connected correctly and is in accordance with the connection diagram.
- Equipment used in hazardous areas must be Ex-approved and marked for Europe, FM for USA and CSA for Canada. It is required that the special conditions for safe use provided in the manual and in the Ex certificate are followed!
- Installation of the equipment must comply with national regulations. For example EN 60079-14 for the European Community.
- Repair and service must be carried out by approved Siemens Flow Instruments personnel only.

DE Sicherheitsanweisungen

⚠ Aus Sicherheitsgründen ist es wichtig, dass Sie die folgenden Punkte lesen und verstehen, bevor Sie das System installieren:

- Installation, Anschluss, Inbetriebnahme und Wartung müssen von Personal ausgeführt werden, das entsprechend qualifiziert ist.
- Es liegt in der Verantwortung des Kunden, dass das betreffende Personal vor der Installation des Gerätes die Anweisungen und Richtungsangaben in diesem Quick-Start und in der Betriebsanleitung auf der beigefügten CD-ROM liest, versteht und befolgt.
- Es liegt in der Verantwortung des Kunden, Personal zum Betrieb des Gerätes anzuweisen und zu berechnen.
- Es liegt in der Verantwortung des Kunden, sicherzustellen, dass das Messinstrument richtig angeschlossen ist und mit dem Anschlussdiagramm übereinstimmt.
- Geräte, die in explosionsgefährdeten Bereichen eingesetzt werden, müssen Ex-zugelassen sein. Sie müssen außerdem für Europa das Ex-Kennzeichen, für die USA das FM-Kennzeichen und für Kanada das CSA-Kennzeichen tragen. Die Sicherheitsvorschriften, die in der Betriebsanleitung und im Ex-Zertifikat angeführt sind, müssen befolgt werden!
- Der Einbau der Geräte muss den nationalen Bestimmungen entsprechen. Beispiel: EN 60079-14 für Dänemark.
- Reparatur und Wartung dürfen nur von Personal durchgeführt werden, das von Siemens Flow Instruments zugelassen ist.

FR Instruction de sécurité**⚠ Pour des raisons de sécurité il est important de se familiariser avec les consignes suivantes:**

- L'installation, les raccordements électriques, la mise en service et l'entretien de l'appareil doivent être réalisés uniquement par le personnel qualifié et autorisé.
- Le client est responsable de la bonne installation de l'appareil en conformité avec les instructions et les consignes fournies dans le Guide de Mise en service et dans le mode d'emploi fournis sur le CD-ROM. Le personnel habilité doit prendre connaissance de ces informations avant l'installation.
- Le client est responsable de la formation adéquate et de l'accès du personnel susceptible d'utiliser l'appareil.
- Le client est responsable de veiller à ce que l'appareil de mesure soit raccordé correctement, en accord avec le schéma de branchement. Les appareils utilisés en zone dangereuse doivent être certifiés : Ex (Europe), FM (USA) et CSA (Canada). Il est impératif de respecter les consignes spécifiques fournies dans le mode d'emploi ainsi que sur le certificat Ex.
- L'appareil doit être installé en accord avec les normes et réglementations locales en vigueur. Par exemple : pour le EU la norme EN 60079-14.
- Seul le personnel technique Siemens Flow Instruments est autorisé à intervenir sur l'appareil pour la réparation et l'entretien.

ES Instrucciones de seguridad**⚠ Por motivos de seguridad es importante leer y entender las siguientes instrucciones antes de instalar el aparato:**

- La instalación, conexión, puesta en marcha y mantenimiento deberán correr a cargo exclusivamente de personal cualificado y autorizado.
- El cliente es responsable de garantizar el respeto de las instrucciones y directivas proporcionadas en la Guía de puesta en marcha y en el manual de usuario incluidos en el CD-ROM. El personal encargado deberá leer el comprender la documentación antes de instalar el aparato.
- El cliente es responsable de formar y proporcionar las autorizaciones necesarias al personal para la utilización del aparato.
- El cliente es responsable de comprobar las conexiones eléctricas del aparato, de conformidad con el esquema de conexiones.
- Los aparatos utilizados en zonas peligrosas deben disponer de certificado para uso en entornos explosivos y llevar las siglas Ex para Europa, FM para EE.UU. y CSA para Canadá. Es obligatorio seguir las instrucciones específicas proporcionadas en el manual y en el certificado Ex (protección contra explosiones).
- La instalación del aparato tiene que cumplir la normativa nacional. Por ejemplo: EN 60079-14 para Dinamarca.
- Las reparaciones y el mantenimiento sólo los pueden realizar personas homologadas por Siemens Flow Instruments.

PT Instruções de segurança

⚠ Por motivos de segurança é importante que leia e compreenda os seguintes pontos antes da instalação do sistema!

- A instalação, ligação, colocação em funcionamento e assistência devem ser efectuadas apenas por pessoal qualificado e autorizado para o efeito.
- É da responsabilidade do cliente certificar-se de que estas instruções e orientações fornecidas no Guia Consulta Rápida e no manual contido no CD-ROM anexo, sejam lidas, compreendidas e seguidas pelo pessoal relevante antes da instalação do equipamento.
- É da responsabilidade do cliente instruir e autorizar pessoal para trabalhar com o equipamento.
- É da responsabilidade do cliente assegurar que o sistema de medição se encontra devidamente ligado e em conformidade com o esquema de ligação.
- O equipamento utilizado em áreas CLASSIFICADAS deve ser aprovado e identificado como Ex para Europa, FM para os EUA, CSA para o Canadá e INMETRO PARA O BRASIL. Para uma utilização segura é obrigatório seguir as condições especiais de segurança fornecidas no manual e no certificado Ex!
- A instalação do equipamento deve cumprir os regulamentos nacionais. Por exemplo, a norma EN 60079-14 para a Comunidade Europeia.

Os reparos e a assistência devem ser efectuadas apenas por pessoal aprovado da Siemens Flow Instruments.

- (EN)** Handling
- (DE)** Handhabung
- (FR)** Manipulation
- (ES)** Manipulación
- (PT)** Manuseio

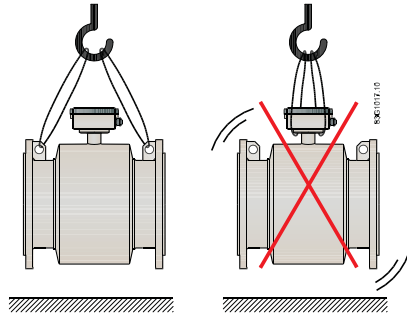



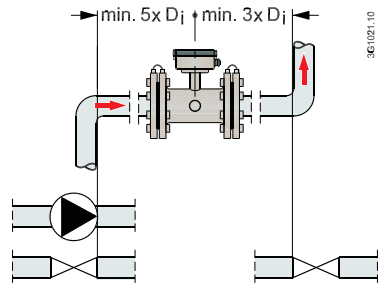

- (EN)** Inlet and outlet conditions
- (DE)** Einlass- und Auslassbedingungen
- (FR)** Conditions d'entrée/de sortie
- (ES)** Condiciones de entrada/salida
- (PT)** Condições de entrada e saída

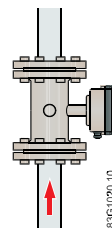

- (EN)** Recommended flow direction
- (DE)** Empfohlene Fließrichtung
- (FR)** Sens de l'écoulement recommandé
- (ES)** Sentido de flujo recomendados
- (PT)** Direcção recomendada de fluxo



- (EN)**  For more information see the operating instructions on the enclosed CD-ROM.
- (DE)**  Weitere Informationen siehe Betriebsanleitung auf der beigefügten CD-ROM.
- (FR)**  Pour plus de detail consulter les instructions d'utilisation sur le CD-ROM fourni.
- (ES)**  Para más información ver las instrucciones de servicio en el CD-ROM.
- (PT)**  Para mais informações, consulte as instruções de funcionamento no CD-ROM anexo.

EN

Flow conditions

 The pipe must be completely filled with liquid!

DE

Fließbedingungen

 Das Rohr muss vollständig mit Flüssigkeit gefüllt sein!

FR

Conditions d'écoulement

 Veiller à ce que la conduite soit entièrement remplie de liquide!

ES

Condiciones de caudal

 ¡La tubería debe estar completamente llena de líquido!

PT

Condições de fluxo

 A tubulação deve estar completamente cheia de líquido!

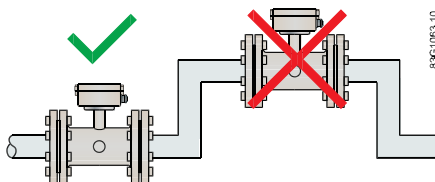
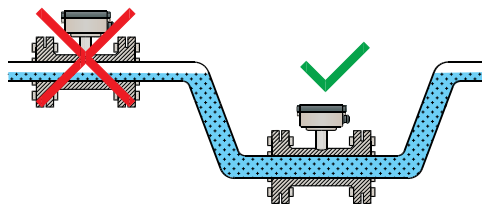
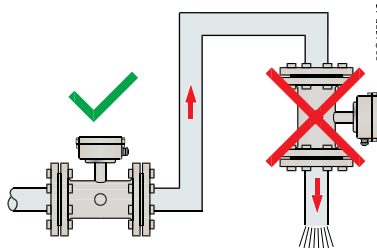
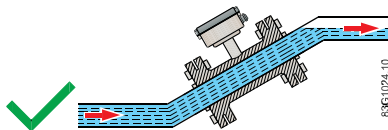

- (EN) ⚠️ Avoid vacuum!
- (DE) ⚠️ Vermeiden Sie Vakuum!
- (FR) ⚠️ Tenir à l'écart des installations sous vide!
- (ES) ⚠️ ¡Evitar el vacío total!
- (PT) ⚠️ Evitar o vácuo!

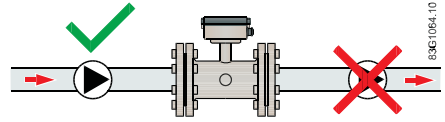

83G1064.10

- (EN) ⚠️ Avoid vibrations!
- (DE) ⚠️ Vermeiden Sie Vibrationen!
- (FR) ⚠️ Tenir à l'écart des vibrations!
- (ES) ⚠️ ¡Evitar las vibraciones!
- (PT) ⚠️ Evitar vibrações!

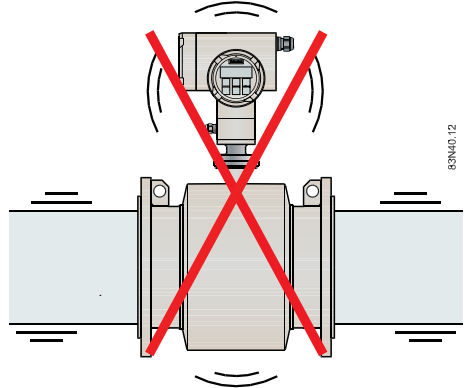

83M40.12

- (EN) Horizontal pipes
- (DE) Horizontale Rohre
- (FR) Conduites horizontales
- (ES) Conductos horizontales
- (PT) Tubulação horizontal

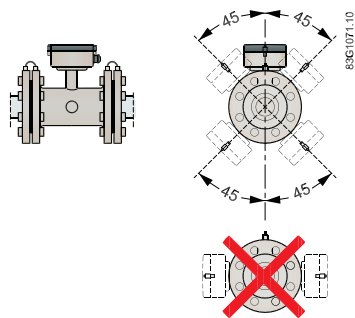

83G1071.10

(EN) Potential equalization
 (DE) Potentialausgleich
 (FR) Egalisation de potentiel

(ES) Ecuación de potencial
 (PT) Equalização potencial

(EN) With earthing electrodes (no further action necessary)
 (DE) Mit Erdungselektroden (keine weitere Handlung nötig)
 (FR) Capteur équipé d'électrodes de terre (ne nécessite aucune action ultérieure)
 (ES) Con electrodos de puesta a tierra (no requieren ulteriores intervenciones)
 (PT) Com electrodos de terra (não são necessárias intervenções posteriores)

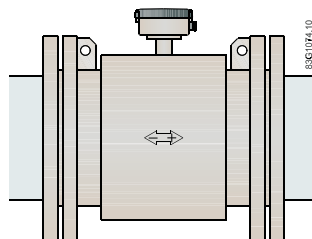



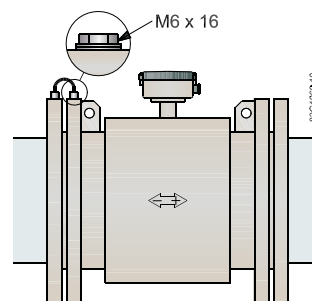

(EN) Without earthing electrodes (MAG 3100 PTFE/PFA) in conductive pipes
 (DE) Ohne Erdungselektroden (MAG 3100 PTFE/PFA) in leitenden Rohren
 (FR) Sans électrodes de mise à la terre (MAG 3100 PTFE/PFA), conduites conductrices
 (ES) Sin electrodos de puesta a tierra (MAG 3100 PTFE/PFA), tuberías conductoras
 (PT) Sem electrodos de terra (MAG 3100 PTFE/PFA) em tubagens condutoras

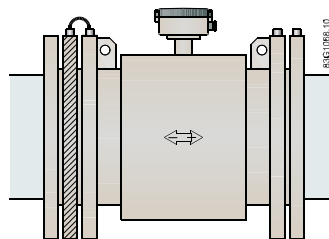

(EN) Without earthing electrodes in non-conductive pipes
 (DE) Ohne Erdungselektroden in nichtleitenden Rohren
 (FR) Sans électrodes de mise à la terre, conduites non conductrices
 (ES) Sin electrodos de puesta a tierra, tuberías no conductoras
 (PT) Sem electrodos de terra em tubagens não condutoras



(EN)  For cathodic protection of pipe systems see the operating instructions on the enclosed CD-ROM.
 (DE)  Kathodischer Schutz der Rohrssysteme siehe Betriebsanleitung auf der beigefügten CD-ROM.
 (FR)  La protection cathodique des tuyauteries et conduites est décrite dans les instructions d'utilisation sur le CD-ROM fourni.
 (ES)  La protección catódica de las tuberías está en las instrucciones de servicio en el CD-ROM.
 (PT)  Para a protecção catódica dos sistemas de tubulação, consultar o manual de funcionamento no CD-ROM anexo.

Quick Start MAG 3100 / 3100HT / 3100P / 5100W



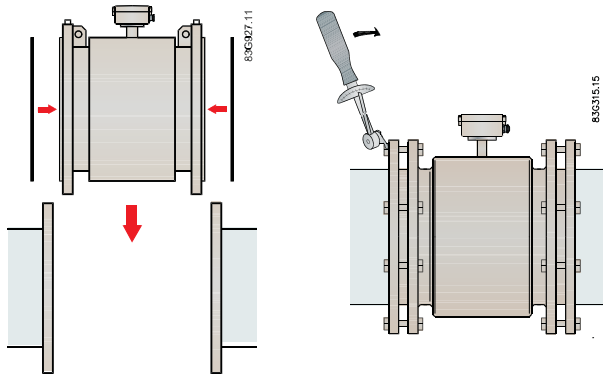







- (EN) Use proper gaskets!
- (DE) Verwenden Sie passende Dichtungsringe!
- (FR) Utiliser des joints adaptés!
- (ES) ¡Use juntas adecuadas!
- (PT) Utilizar juntas apropriadas!



- (EN) The following torque values are calculated on the basis of use of gaskets. For further calculations of preconditions refer to the operating manual on the enclosed CD-ROM.
- (DE) Die folgenden Drehmomentwerte wurden unter der Annahme berechnet, dass Dichtungsringe verwendet werden. Für weitere Berechnungen siehe Bedienhandbuch auf der beigefügten CD-ROM.
- (FR) Les valeurs de couple de serrage sont calculées en tenant compte de l'utilisation de joints. Pour plus de calculs relatifs aux conditions requises se reporter manuel d'utilisation sur le CD-ROM fourni.
- (ES) Los valores de torsión se calculan en base a la utilización de juntas. Para más cálculos ver el manual de usuario en el CD-ROM.
- (PT) Os valores de torque seguintes são calculados com base no uso das juntas. Para mais cálculos de pré-condições, consulte o manual de funcionamento no CD-ROM anexo.

DN		Max. torque / Max. Drehmoment / Couples maximum / Pares máximos / Torque máximo															
		ANSI B 16.5				AS 2129				AS 4087				JIS B 2220:2004			
		Class 150		Class 300		Table E		PN16		PN21		PN35		K10		K20	
mm	inch	Nm	F/ Lbs	Nm	F/ Lbs	Nm	F/ Lbs	Nm	F/ Lbs	Nm	F/ Lbs	Nm	F/ Lbs	Nm	F/ Lbs	Nm	F/ Lbs
15	0,5"	N/A	N/A	3	2	6	4	N/A	N/A	N/A	N/A	N/A	N/A	8	6	8	6
25	1"	7	5	7	5	9	7	N/A	N/A	N/A	N/A	N/A	N/A	16	12	16	12
40	1,5"	9	7	18	13	17	13	N/A	N/A	N/A	N/A	N/A	N/A	20	15	20	15
50	2"	20	14	11	8	20	15	21	15	33	24	33	24	27	20	13	10
65	2,5"	25	18	16	12	21	16	22	16	22	16	22	16	36	27	18	13
80	3"	34	25	24	18	32	23	32	24	28	21	28	21	21	16	28	21
100	4"	26	19	34	25	24	18	50	37	35	26	35	26	26	19	37	27
125	5"	42	31	42	31	33	24	N/A	N/A	N/A	N/A	N/A	N/A	43	32	59	44
150	6"	57	42	35	26	40	30	60	44	50	37	50	37	76	56	40	30
200	8"	88	65	57	42	61	45	55	41	78	57	37	28	46	34	62	45
250	10"	99	73	57	42	62	46	94	70	110	81	49	36	72	53	113	83
300	12"	132	97	86	63	78	58	72	53	105	77	43	32	56	41	96	71
350	14"	225	166	N/A	N/A	147	109	153	113	164	121	94	69	72	53	147	108
400	16"	210	155	N/A	N/A	168	124	172	127	158	116	105	77	115	85	175	129
450	18"	220	162	N/A	N/A	164	121	224	165	204	151	129	95	109	80	184	135
500	20"	200	148	N/A	N/A	194	143	198	146	210	155	141	104	127	93	211	155
600	24"	280	207	N/A	N/A	306	225	287	211	277	204	183	135	150	111	255	188
700	28"	N/A	N/A	N/A	N/A	236	174	228	168	246	182	207	153	N/A	N/A	N/A	N/A
750	30"	N/A	N/A	N/A	N/A	N/A	N/A	N/A	N/A	N/A	N/A	N/A	N/A	N/A	N/A	N/A	N/A
800	32"	N/A	N/A	N/A	N/A	413	305	426	314	304	224	286	211	N/A	N/A	N/A	N/A
900	36"	N/A	N/A	N/A	N/A	407	300	416	307	371	274	287	212	N/A	N/A	N/A	N/A
1000	40"	N/A	N/A	N/A	N/A	400	295	386	284	326	240	326	240	N/A	N/A	N/A	N/A
1200	48"	N/A	N/A	N/A	N/A	469	346	443	327	471	347	471	347	N/A	N/A	N/A	N/A

Max. torque / Max. Drehmoment / Couples maximum / Pares máximos / Torque máximo																	
DN		EN 1092-1														AWWA	
		PN6		PN10		PN16		PN25		PN40		PN63		PN100		Class D	
mm	inch	Nm	F/Lbs	Nm	F/Lbs	Nm	F/Lbs	Nm	F/Lbs	Nm	F/Lbs	Nm	F/Lbs	Nm	F/Lbs	Nm	F/Lbs
15	0,5"	N/A	N/A	N/A	N/A	N/A	N/A	N/A	N/A	10	7	N/A	N/A	N/A	N/A	N/A	N/A
25	1"	N/A	N/A	N/A	N/A	N/A	N/A	N/A	N/A	16	12	N/A	N/A	25	18	N/A	N/A
40	1,5"	N/A	N/A	N/A	N/A	N/A	N/A	N/A	N/A	34	25	N/A	N/A	52	38	N/A	N/A
50	2"	N/A	N/A	N/A	N/A	N/A	N/A	N/A	N/A	46	34	45	33	83	61	N/A	N/A
65	2,5"	10	7	N/A	N/A	25	18	N/A	N/A	34	25	32	23	60	44	N/A	N/A
80	3"	25	18	N/A	N/A	25	18	N/A	N/A	42	31	41	30	76	56	N/A	N/A
100	4"	25	18	N/A	N/A	25	18	N/A	N/A	72	53	68	50	118	87	N/A	N/A
125	5"	25	18	N/A	N/A	32	24	N/A	N/A	114	84	102	75	177	130	N/A	N/A
150	6"	25	18	N/A	N/A	50	37	N/A	N/A	144	106	153	112	159	117	N/A	N/A
200	8"	25	18	50	37	52	38	105	77	185	137	189	139	294	216	N/A	N/A
250	10"	25	18	50	37	88	65	160	118	300	221	276	203	472	348	N/A	N/A
300	12"	50	37	60	44	117	86	170	125	320	236	293	216	541	399	N/A	N/A
350	14"	50	37	60	44	120	89	240	177	450	332	413	304	800	590	N/A	N/A
400	16"	50	37	88	65	170	125	330	244	650	480	588	431	N/A	N/A	N/A	N/A
450	18"	56	41	92	68	170	125	320	236	570	421	N/A	N/A	N/A	N/A	N/A	N/A
500	20"	53	39	103	76	230	170	390	288	740	546	N/A	N/A	N/A	N/A	N/A	N/A
600	24"	81	60	161	119	350	258	560	413	1220	900	N/A	N/A	N/A	N/A	N/A	N/A
700	28"	48	35	96	71	183	135	N/A	N/A	N/A	N/A	N/A	N/A	N/A	N/A	250	184
800	32"	70	52	137	101	257	190	N/A	N/A	N/A	N/A	N/A	N/A	N/A	N/A	329	242
900	36"	86	63	144	106	272	201	N/A	N/A	N/A	N/A	N/A	N/A	N/A	N/A	339	250
1000	40"	90	66	191	141	364	268	N/A	N/A	N/A	N/A	N/A	N/A	N/A	N/A	393	290
1050	42"	N/A	N/A	N/A	N/A	N/A	N/A	N/A	N/A	N/A	N/A	N/A	N/A	N/A	N/A	366	270
1100	44"	N/A	N/A	N/A	N/A	N/A	N/A	N/A	N/A	N/A	N/A	N/A	N/A	N/A	N/A	471	347
1200	48"	126	93	263	194	522	385	N/A	N/A	N/A	N/A	N/A	N/A	N/A	N/A	436	322
1400	54"	165	122	335	247	613	452	N/A	N/A	N/A	N/A	N/A	N/A	N/A	N/A	528	389
1600	66"	190	140	456	336	830	612	N/A	N/A	N/A	N/A	N/A	N/A	N/A	N/A	698	515
1800	72"	239	176	514	379	937	692	N/A	N/A	N/A	N/A	N/A	N/A	N/A	N/A	700	516
2000	78"	288	212	578	426	1128	832	N/A	N/A	N/A	N/A	N/A	N/A	N/A	N/A	890	656

-   For more information see the operating instructions on the enclosed CD-ROM.
  Weitere Informationen siehe Betriebsanleitung auf der beigefügten CD-ROM.
  Pour plus de détail consulter les instructions d'utilisation sur le CD-ROM fourni.
  Para más información ver las instrucciones de servicio en el CD-ROM.
  Para mais informações, consulte as instruções de funcionamento no CD-ROM anexo.

(EN) Remote installation
 (DE) Getrennte Montage
 (FR) Installation déportée

(ES) Instalación remota
 (PT) Instalação remota

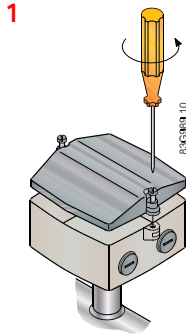

- (EN) Relocation of Sensorprom. Refer to the relevant transmitter Quick Start
 (DE) Umstecken des Sensorprom. Siehe Quick-Start des entsprechenden Messumformers
 (FR) Repositionner le Sensorprom. Se reporter au guide de Quick Start.
 (ES) Reubicar Sensorprom. Ver la guía de Quick Start
 (PT) Reposicionamento do Sensorprom. Consulte o guia de consulta rápido do transmissor relevante.

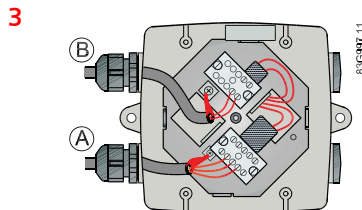
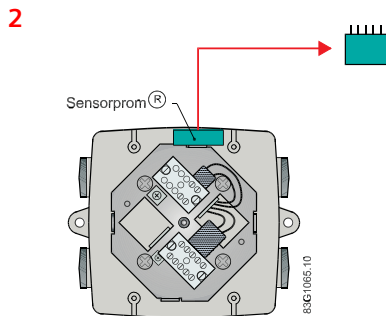

(EN) Electrical connection (fig. 4). (A) Sensor, (B) Electrode cable, (C) Coil cable, (D) Only required for ATEX applications!

 For cable specifications see the operating manual on the enclosed CD-ROM.

(DE) Elektrischer Anschluss (Abb. 4). (A) Messaufnehmer, (B) Elektrodenkabel, (C) Spulenkabel, (D) Nur für ATEX-Anwendungen erforderlich!

 Kabelspezifikationen siehe Bedienhandbuch auf der beigelegten CD.

(FR) Connexion électrique (fig. 4). (A) Capteur, (B) câble d'électrode, (C) Câble charge, (D) Requis uniquement pour les applications ATEX!

 Pour plus de détails sur le câblage se reporter manuel d'utilisation sur le CD-ROM fourni.

(ES) Conexión eléctrica (fig. 4). (A) Sensor, (B) cable d'electrode, (C) Cable cargador, (D) Sólo para aplicaciones ATEX!

 Más detalles acerca del cableado en el manual del usuario en el CD.

(PT) Ligaç o el ctrica (fig. 4). (A) Sensor, (B) Cabo do el ctrodo, (C) Cabo da Bobina, (D) Apenas requeridos para aplica  es ATEX!

 Para especifica  es de cabo, consulte o manual de funcionamento no CD-ROM anexo.

4

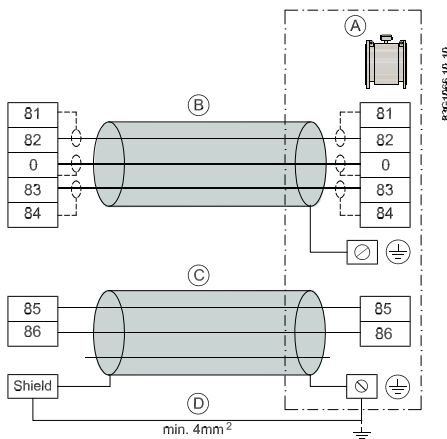

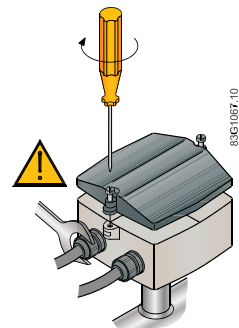

5



(EN)  Make sure cable glands are firmly sealed!

(DE)  Stellen Sie sicher, dass die Kabelverschraubungen fest verschlossen sind.

(FR)  Veiller   ce que les presse  toupes soient  tanches!

(ES)   Comprobar el sellado adecuado de los prensaestopas;

(PT)  Certifique-se de que os prensa-cabos se encontram firmemente selados!

(EN) Potting kit for IP 68 application.

⚠ Do not use with ATEX sensors!

(DE) Silikongel für IP68-Aufgaben.

⚠ Nicht mit ATEX Messaufnehmer verwenden

(FR) Kit d'empotage pour application IP 68.

⚠ Ne pas associer à des capteurs ATEX !

(ES) Kit de encapsulado para aplicación IP 68.

⚠ ¡No utilizar con sensores ATEX!

(PT) Kit de isolamento para aplicação IP 68

⚠ Não utilizar com sensores ATEX ou inmetro!

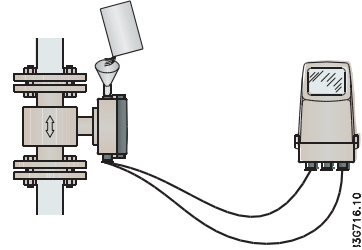
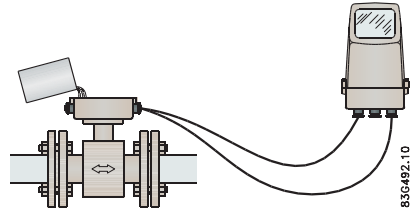
**(EN) Recommendation for direct burial of remote sensor**

⚠ Check for visible damages in paint finish! Use protection conduit! Protect sensor with pea gravel.

(DE) Empfehlung für die direkte Erdverlegung entfernter Messaufnehmer

⚠ Prüfen Sie die Oberfläche auf sichtbare Schäden! Verwenden Sie eine Schutzisolierung. Schützen Sie den Messaufnehmer mit Split.

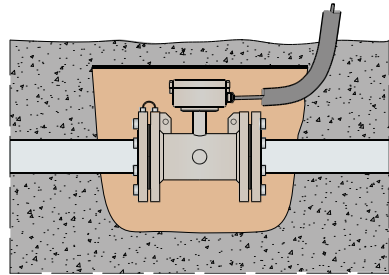
**(FR) Suggestion pour l'enfouissement direct du capteur à distance**

⚠ Vérifier que la surface peinte ne présente pas de dommages visibles. Utiliser un conduit de protection. Protéger le capteur avec du gravillon.

(ES) Sugerencia para enterrar directamente el sensor remoto

⚠ ¡Revise el revestimiento de pintura para comprobar que no presente daños o imperfecciones! ¡Utilizar un conducto de protección! Proteger el sensor con gravilla.

(PT) Recomendação para o enterramento directo do sensor remoto

⚠ Verifique a existência de danos visíveis no acabamento da tinta! Utilizar um eletroduto de protecção! Proteger o sensor com gravilha fina.

(EN)  For more information see the operating instructions on the enclosed CD-ROM.

(DE)  Weitere Informationen siehe Betriebsanleitung auf der beigefügten CD-ROM.

(FR)  Pour plus de detail consulter les instructions d'utilisation sur le CD-ROM fourni.

(ES)  Para más información ver las instrucciones de servicio en el CD-ROM.

(PT)  Para mais informações, consulte as instruções de funcionamento no CD-ROM anexo.

- (EN)** For MAG 5100 W with custody transfer approval, please refer to the following certificates:
OIML R 49 pattern approval cold water (Denmark and Germany):
DN 50 ... 300 (2" ... 12") (08-3412 TS 22.36 005 or PTB 6.221/05.21)
MI 001 cold water (EU):
DN 50 ... 300 (2" ... 12"). Approval (DK-0200-MI001-001)
- (DE)** Beim MAG 5100 W mit Zulassungen für den eichpflichtigen Verkehr beachten Sie bitte folgende Zertifikate:
OIML R 49 Kaltwasserzulassung (Dänemark und Deutschland):
DN 50 ... 300 (2" ... 12") (08-3412 TS 22.36 005 oder PTB 6.221/05.21)
MI 001 Kaltwasser (EU):
DN 50 ... 300 (2" ... 12"). Zulassung (DK-0200-MI001-001)
- (FR)** Pour les débitmètres MAG 5100 W homologués pour transactions commerciales veuillez consulter les certificats suivants :
Homologation OIML R 49 compteur d'eau froide (Danemark et Allemagne) :
DN 50 ... 300 (2" ... 12") (08-3412 TS 22.36 005 ou PTB 6.221/05.21)
MI 001 compteur d'eau froide (UE) :
DN 50 ... 300 (2" ... 12"). Homologation (DK-0200-MI001-001)
- (ES)** Para sensores MAG 5100 W homologados para transacciones con verificación obligatoria véanse los siguientes certificados :
Aprobación OIML R 49 (agua fría) (Dinamarca y Alemania):
DN 50 ... 300 (2" ... 12") (08-3412 TS 22.36 005 ó PTB 6.221/05.21)
MI 001 agua fría (UE):
DN 50 ... 300 (2" ... 12"). Aprobación (DK-0200-MI001-001)
- (PT)** Para o MAG 5100 W com aprovações de transferência de custódia, consulte os seguintes certificados:
Aprovação do padrão OIML R 49 para água fria (Dinamarca e Alemanha):
DN 50 ... 300 (2" ... 12") (08-3412 TS 22.36 005 ou PTB 6.221/05.21)
MI 001 para água fria (UE):
DN 50 ... 300 (2" ... 12"). Aprovação (DK-0200-MI001-001)



EN We have reviewed the contents of this publication to ensure consistency with the hardware and software described. Since variance cannot be precluded entirely, we cannot guarantee full consistency. However, the information in this publication is reviewed regularly and any necessary corrections are included in subsequent editions. Responsibility for suitability and intended use of this instrument rests solely with the user.

Copyright © Siemens AG 02.2009 All Rights Reserved. Technical data subject to change without prior notice.

DE Wir haben den Inhalt der Druckschrift auf Übereinstimmung mit der beschriebenen Hard- und Software geprüft. Dennoch können Abweichungen nicht ausgeschlossen werden, so dass wir für die vollständige Übereinstimmung keine Gewähr übernehmen. Die Angaben in dieser Druckschrift werden regelmäßig überprüft, notwendige Korrekturen sind in den nachfolgenden Auflagen enthalten. Der Benutzer ist allein verantwortlich für Eignung und Bestimmungszweck dieses Gerätes.

Copyright © Siemens AG 02.2009 All Rights Reserved. Änderungen vorbehalten.

FR Nous avons vérifié la conformité du contenu du présent document avec le matériel et le logiciel qui y sont décrits. Ne pouvant toutefois exclure toute divergence, nous ne pouvons pas nous porter garants de la conformité intégrale. Si l'usage de ce manuel devait révéler des erreurs, nous en tiendrons compte et apporterons les corrections nécessaires dès la prochaine édition. La responsabilité concernant l'usage approprié et prévu de l'instrument incombe à l'utilisateur.

Copyright © Siemens AG 02.2009 All Rights Reserved. Sous réserve de modifications techniques.

ES Hemos revisado el contenido de esta publicación para asegurar la consistencia con el hardware y el software descritos. Sin embargo, como es imposible excluir desviaciones, no podemos hacernos responsable de la plena consistencia. El contenido de esta publicación se revisa periódicamente; si es necesario, las posibles correcciones se incluyen en la siguiente edición. La responsabilidad relativa a la conveniencia y al uso supuesto de este instrumento es exclusivamente del usuario.

Copyright © Siemens AG 02.2009 All Rights Reserved. Sujeto a cambios sin previo aviso.

PT Analisámos o conteúdo desta publicação para assegurar a concordância com o hardware e o software descritos. Uma vez que a discrepância não pode ser impedida por completo, não podemos garantir uma concordância total. No entanto, as informações desta publicação são revistas com regularidade, sendo as correções necessárias incluídas nas edições seguintes. É da total responsabilidade do utilizador a adequabilidade e o uso pretendido deste dispositivo.

Copyright © Siemens AG 02.2009 Todos os Direitos Reservados. Os dados técnicos estão sujeitos a alterações sem aviso prévio.

Siemens Flow Instruments A/S
6430 NORDBORG
DENMARK
www.siemens.com/flowdocumentation



Order no.: A5E01223060-06
Literature no.: SFIDK.PQ.027.F6.5C