



million
in one

hydroranger

PLUS

MILLTRONICS

Safety Guidelines: Warning notices must be observed to ensure personal safety as well as that of others, and to protect the product and the connected equipment. These warning notices are accompanied by a clarification of the level of caution to be observed.

Qualified Personnel: This device/system may only be set up and operated in conjunction with this manual. Qualified personnel are only authorized to install and operate this equipment in accordance with established safety practices and standards.

Unit Repair and Excluded Liability:

- The user is responsible for all changes and repairs made to the device by the user or the user's agent.
- All new components are to be provided by Siemens Milltronics Process Instruments Inc.
- Restrict repair to faulty components only.
- Do not reuse faulty components.

Warning: This product can only function properly and safely if it is correctly transported, stored, installed, set up, operated, and maintained.

Note: Always use product in accordance with specifications.

| Copyright Siemens Milltronics Process Instruments Inc. 2005. All Rights Reserved | Disclaimer of Liability |
|---|--|
| This document is available in bound version and in electronic version. We encourage users to purchase authorized bound manuals, or to view electronic versions as designed and authored by Siemens Milltronics Process Instruments Inc. Siemens Milltronics Process Instruments Inc. will not be responsible for the contents of partial or whole reproductions of either bound or electronic versions. | While we have verified the contents of this manual for agreement with the instrumentation described, variations remain possible. Thus we cannot guarantee full agreement. The contents of this manual are regularly reviewed and corrections are included in subsequent editions. We welcome all suggestions for improvement. Technical data subject to change. |

MILLTRONICS® is a registered trademark of Siemens Milltronics Process Instruments Inc.

Contact SMPI Technical Publications at the following address:

Technical Publications
Siemens Milltronics Process Instruments Inc.
1954 Technology Drive, P.O. Box 4225
Peterborough, Ontario, Canada, K9J 7B1
Email: techpubs.smpi@siemens.com

- For a selection of Siemens Milltronics level measurement manuals, go to: www.siemens.com/processautomation. Under Process Instrumentation, select *Level Measurement* and then go to the manual archive listed under the product family.
- For a selection of Siemens Milltronics weighing manuals, go to: www.siemens.com/processautomation. Under Weighing Technology, select *Continuous Weighing Systems* and then go to the manual archive listed under the product family.

TABLE OF CONTENTS

| TITLE | PAGE # |
|-------------------------------------|--------|
| INTRODUCTION | |
| About this Manual | 5 |
| About the HydroRanger Plus | 6 |
| Important HydroRanger Plus Features | 8 |
| INSTALLATION | |
| Environmental | 9 |
| Outline | 9 |
| Mounting | 11 |
| Programmer | 17 |
| ComVerter | 17 |
| Interconnection | 18 |
| PROGRAMMING | |
| Program Mode Entry | 27 |
| Display | 28 |
| Keypad | 29 |
| Parameter Value Alteration | 31 |
| Special Parameters | 31 |
| Parameter Reset Features | 31 |
| Programming Security | 32 |
| OPERATION | |
| Run Mode Entry | 33 |
| Display | 34 |
| Keypad | 35 |
| System Performance Evaluation | 36 |
| Performance Test Results | 37 |
| Maintaining Operation | 38 |
| APPLICATIONS | |
| General Application | 39 |
| Wet Well Control (Pump Down) | 42 |
| Reservoir Control (Pump Up) | 44 |
| Rake Control (Differential Level) | 46 |
| Penstock Control | 48 |
| General Alarms | 50 |
| OCM (Open Channel Monitor) | 52 |
| Volume Calculation | 54 |
| Pumped Volume Total | 56 |
| Failsafe Operation | 58 |
| Application Assistance | 60 |

| TITLE | PAGE # |
|----------------------------|---------------|
| PARAMETERS | |
| Security | 61 |
| Quick Start | 62 |
| Volume | 65 |
| Reading | 67 |
| Failsafe | 69 |
| Relays | 71 |
| mA Output | 89 |
| mA Input | 94 |
| Data Logging | 95 |
| OCM | 105 |
| Totalizer | 119 |
| Range Calibration | 122 |
| Temperature Compensation | 124 |
| Rate | 126 |
| Measurement Verification | 128 |
| Scanning | 130 |
| Display | 131 |
| Echo Processing | 133 |
| Advanced Echo Processing | 136 |
| Test | 144 |
| Measurement | 146 |
| Master Reset | 148 |
| TECHNICAL REFERENCE | |
| Transmit Pulse | 149 |
| Echo Processing | 149 |
| Scope Displays | 149 |
| Distance Calculation | 150 |
| Sound Velocity | 150 |
| Scanning | 151 |
| Volume Calculation | 152 |
| Flow Calculation | 153 |
| Measurement Response | 154 |
| Relay Set Up | 155 |
| Maintenance | 156 |
| TROUBLESHOOTING | |
| Troubleshooting Chart | 157 |
| Measurement Difficulties | 158 |
| SPECIFICATIONS | |
| HydroRanger Plus | 161 |
| Programmer | 163 |
| Options | 163 |
| PROGRAMMING CHART | 165 |

INTRODUCTION

ABOUT THIS MANUAL

This instruction manual provides information specific to the Milltronics *HydroRanger Plus* (HYDRO+) level monitor. Other products (including transducers) associated with a HYDRO+ based level monitoring system, are supplied with individual instructions.

All general start up information is included in the white pages. Refer to the grey pages for additional information or technical assistance, if required.

After reading this **INTRODUCTION** and completing the physical **INSTALLATION**, first time system installers may wish to use the *HYDRORANGER PLUS Quick Start Guide, PL-439* for step by step start up instructions.

| | |
|------------------------------|---|
| <i>INTRODUCTION</i> | briefly describes key features. |
| <i>INSTALLATION</i> | step by step mounting and wiring procedure. |
| <i>PROGRAMMING</i> | program mode LCD and keypad functions. |
| <i>OPERATION</i> | run mode LCD and keypad functions. |
| <i>APPLICATIONS</i> | 10 brief examples of common HYDRO+ uses. |
| <i>PARAMETERS</i> | specific programmable feature definitions. |
| <i>TECHNICAL REFERENCE</i> | detailed information for complex features. |
| <i>TROUBLESHOOTING GUIDE</i> | quick problem solving techniques. |
| <i>SPECIFICATIONS</i> | lists physical and operational characteristics. |
| <i>PROGRAMMING CHART</i> | space to record all programming for future reference. (Also used as a Parameter index). |

REMEMBER!

"Programming is not complete until the Programming Charts are completed".

*This manual applies to the wall, rack, and panel mount HYDRO+ versions.

For simplicity, the rack mount version is illustrated only where necessary to identify version differences.

Throughout this manual (unless stated otherwise) "level" refers to the relative position of a monitored liquid surface.

ABOUT THE HYDRORANGER PLUS

The HydroRanger Plus is to be used only in the manner outlined in the instruction manual.

The HYDRO+ includes the features of the successful Milltronics "HydroRanger 1" **PLUS** a variety of new features, incorporating advances in electronic component, manufacturing, and software technology.

This multi-purpose microprocessor based level monitor contains numerous features ideally suited for liquid monitoring and pump control applications.

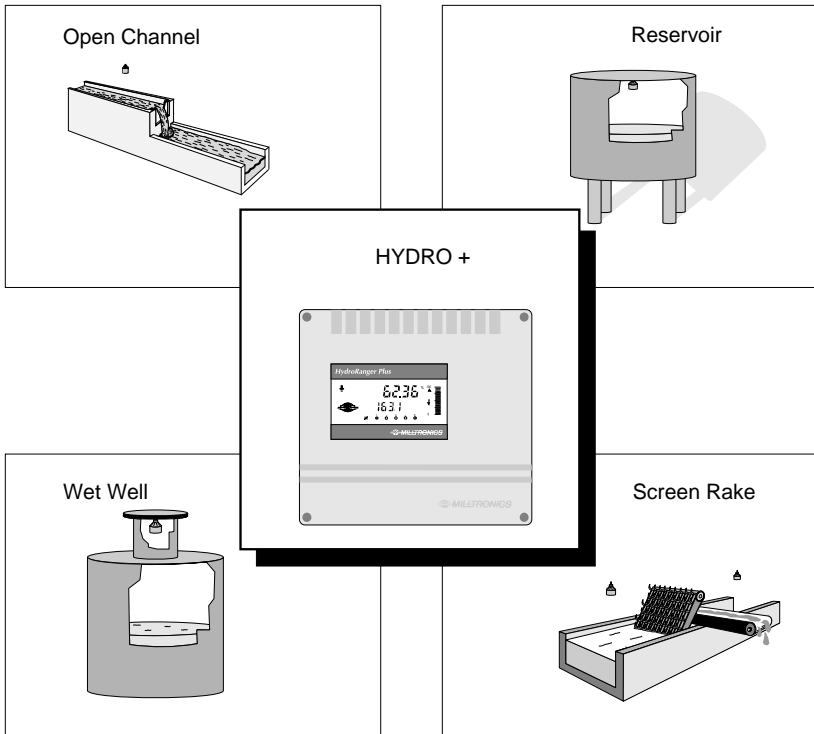

A HYDRO+ level monitor, utilizing a single ultrasonic transducer (ordered separately), accurately monitors level without contacting the surface monitored.

The HYDRO+ provides the transmit pulse to the transducer. The transducer emits ultrasonic pulses in a narrow beam, perpendicular from the transducer face. The HYDRO+ measures the time between pulse emission and reflection (echo) reception, to calculate the transducer face to monitored surface distance.

The transducer internal temperature sensor is used to automatically compensate for sound velocity variations due to air temperature changes within the measurement range.

The HYDRO+ monitors levels 0.3 to 15 m (1 to 50 ft) from the transducer face, with outstanding accuracy, usually within 0.25% of range. (Ensure the transducer selected suits the material and measurement range monitored).

This versatility is accomplished by Milltronics patented Sonic Intelligence™, providing high measurement reliability, regardless of operating conditions.

The HYDRO+ provides the following LCD (Liquid Crystal Display) Readings:

- » Level, space, distance, volume, or remaining capacity in open or closed vessels.
- » Differential level across a channel filter or screen (2 transducers required).
- » Average level in a large vessel with an uneven material surface (2 transducers).
- » Head, flow, or totalized flow in free flowing open channels.
- » Pumped volume from wet wells or into reservoirs.

The HYDRO+ relays and/or mA output may be used as preset (or programmed as desired) to activate alarms, pump controls, chart recorders, or virtually any process control equipment.

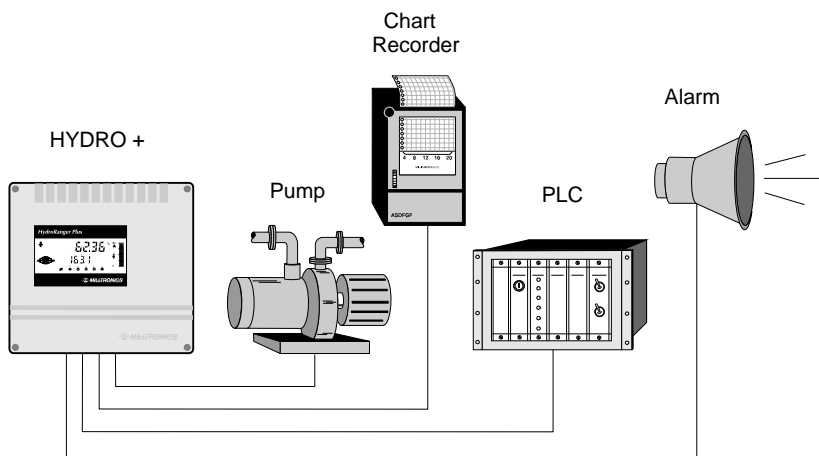

The HYDRO+ infrared interface permits one programmer to be used for any number of HYDRO+ level monitors. Upon programming completion, the programmer may be locked away for programming security. All Operator programming is stored in non-volatile memory, unaffected by power interruption.

While the HYDRO+ is typically used to monitor liquid level, any process which requires a distance measurement or object presence/lack of presence (within the system maximum measurement range) is a candidate for HYDRO+ application.

Refer to APPLICATIONS for detailed descriptions of a small sample of process measurement requirements to which the HYDRO+ may be applied.

IMPORTANT HYDRORANGER PLUS FEATURES

FIXED FEATURES

| | |
|---------------------|---|
| ENCLOSURE: | Chemical resistant, light weight, dust/liquid tight. |
| LCD: | Large digits and symbols for Readings and continuous operating condition indication. |
| HAND PROGRAMMER: | 20 tactile feedback keys, (ordered separately). |
| DOLPHIN COMPATIBLE: | HYDRO+ / RS 232C interface, (ordered separately). |
| COMMUNICATIONS: | Non-invasive infra-red digital data transfer. |
| SPEED: | 16/32 bit microprocessor at 16.7 MHz clock speed. |
| RELIABILITY: | Sonic Intelligence™ Surface Mount Technology (SMT) Immune to power interruptions. All programming is retained indefinitely. Operating data is retained for 30 seconds min; updated promptly upon resumption. |

PROGRAMMABLE FEATURES

Typically, a very small percentage of the HYDRO+ operator programmable features require alteration from default settings. However, for demanding measurement requirements any number of features may be adjusted as required.

Following is a list of the features that make the HYDRO+ easy to program, yet versatile enough to handle complex level measurement requirements.

GENERAL FEATURES

| | |
|----------------|---|
| DIRECT ACCESS: | Any operator programmable feature may be accessed directly. |
| SCROLL ACCESS: | Scroll forward or backward to key programmable features. |
| OPERATION: | 7 modes of operation to suit specific requirements. |
| MATERIAL: | Preset for optimum performance on all liquid surfaces. |
| RESPONSE: | Slow, medium, or fast response to level changes. |
| UNITS: | Readings in m, cm, mm, ft, in, %, (or any other units desired). |

ADDITIONAL FEATURES *(use as desired)*

| | |
|---------------|--|
| VOLUME: | 8 pre-programmed tank shape options 2 universal tank shape programming methods |
| FLOW: | Open channel flowrate and total, 5 pre-programmed flumes. |
| PUMPED TOTAL: | Total volume pumped including/excluding inflow/discharge. |
| DATA LOGS: | Time and Date of important operational events. |
| FAIL-SAFE: | Automatic process control equipment activation. |
| RELAYS: | 6 alarm functions, 7 pump functions, 5 control functions, storm condition and energy saving pump function modifiers. |
| mA OUTPUT: | 7 functions, range selectable and scalable, overrange limits. |
| mA INPUT: | HYDRO+ features based on any level monitor mA output. |

INSTALLATION

Installation shall only be performed by qualified personnel,
and in accordance with local governing regulations.

ENVIRONMENTAL

Choose a mounting location suited to the HYDRO+ enclosure.

The ideal HYDRO+ mounting location is where the:

1. Ambient temperature is always within -20 to 50°C (-5 to 122°F).
2. HYDRO+ display window is at eye level.
3. Cable length requirements are minimal.
4. Mounting surface is free from vibration.

Avoid mounting locations where the HYDRO+ is:

- » exposed to direct sunlight, (otherwise, provide a sun shield).
- » close to high voltage/current runs, contactors, SCR control drives, or frequency inverters.

**This product is susceptible to electrostatic shock.
Follow proper grounding procedures.**

OUTLINE

WALL MOUNT

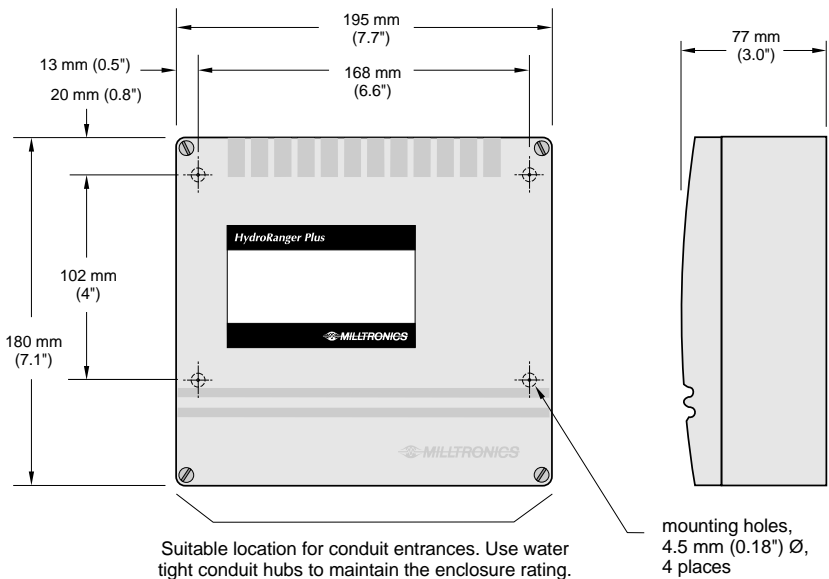

Non metallic enclosure does not provide grounding between conduit connections. Use grounding type bushings and jumpers.

RACK MOUNT

The HYDRO+ rack mount version is a standard DIN 3U/14 HP, 4 rail plug-in unit, for a standard 84 HP deep sub-rack.

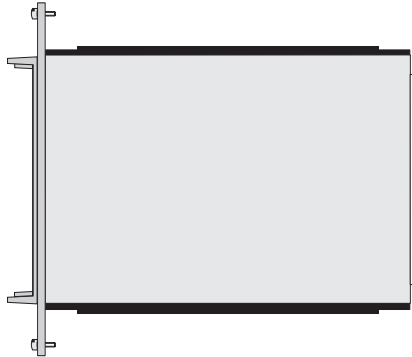
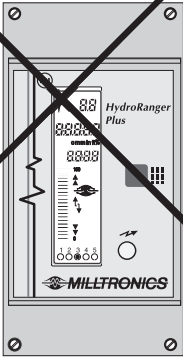

PANEL MOUNT

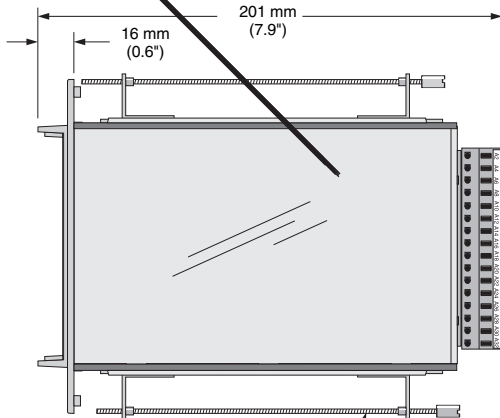
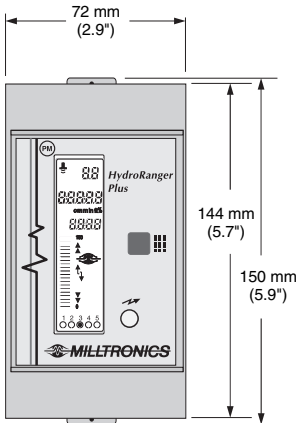

slip on mounting bracket top & bottom
screws to be tightened to no more than
1 inch / lb. torque.

MOUNTING

WALL MOUNT

Voltage Selection

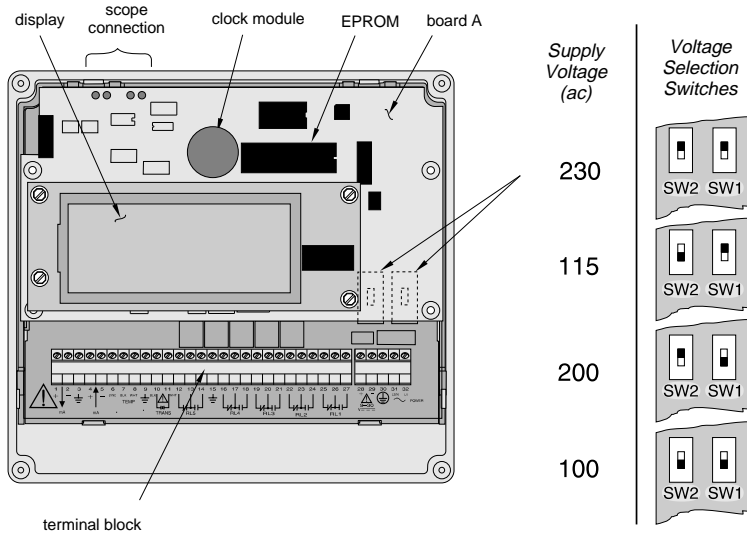

All field wiring must have insulation suitable for at least 250 V .



Hazardous voltage present on transducer terminals during operation.



dc terminals shall be supplied from an SELV source in accordance with IEC 1010-1 Annex H.

Relay contact terminals are for use with equipment having no accessible live parts and wiring having insulation suitable for at least 250 V .

The maximum allowable working voltage between adjacent relay contacts shall be 250 V .

Installation

The HYDRO+ wall mount version enclosure design permits quick electronic package removal for enclosure drilling and mounting.

1. Remove the HYDRO+ enclosure lid (4 captivated screws).
2. With the enclosure upright, press down enclosure TABS A and B.
3. Push in on TABS C and D to release the electronics package.
4. Drill sufficient holes for cable / conduit entry in the enclosure bottom.
5. Fasten the enclosure to the mounting surface, (4 predrilled screw holes).
6. Attach the conduit / cable hubs to the enclosure. (Do not apply undue force.)
7. Snap the electronics package back into the enclosure.

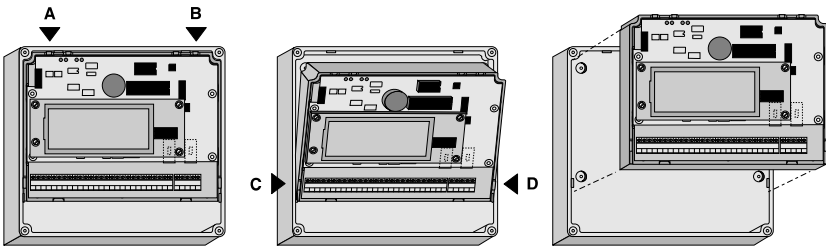

RACK MOUNT

Voltage Selection

1. Set the voltage switches.

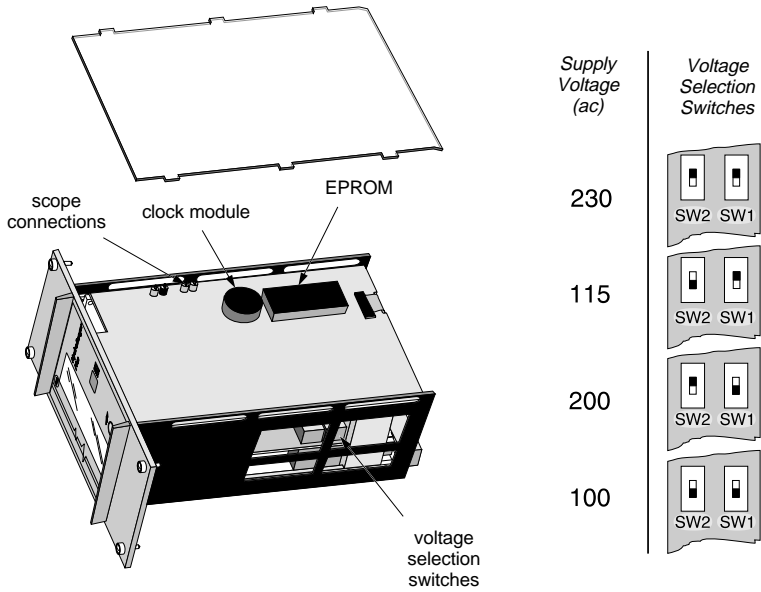

Installation

- Slide the Hydro+ into the sub-rack, aligning the connector with the rail mounted terminal block.

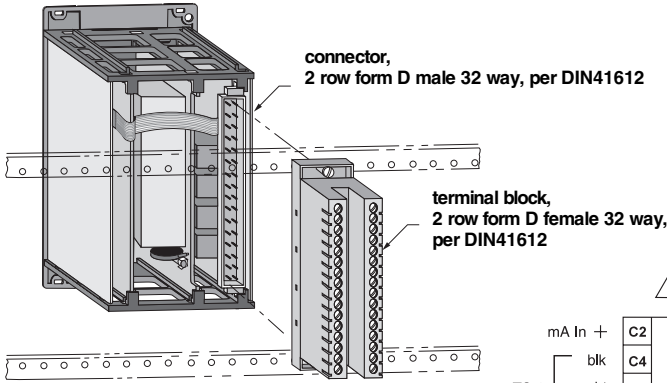

- ⚠ All field wiring must have insulation suitable for at least 250 V .
- ⚠ Hazardous voltage present on transducer terminals during operation.
- ⚠ dc terminals shall be supplied from an SELV source in accordance with IEC 1010-1 Annex H.

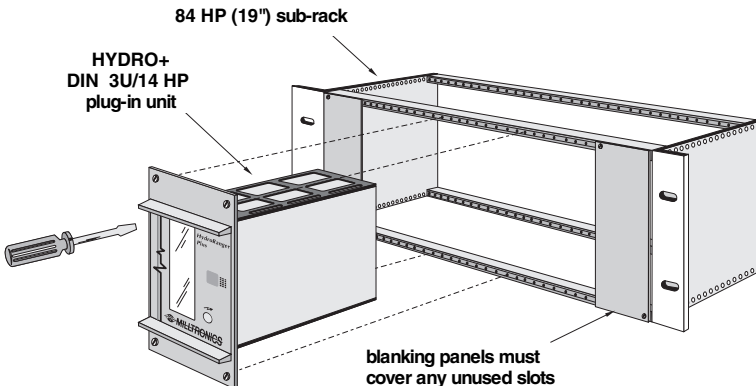
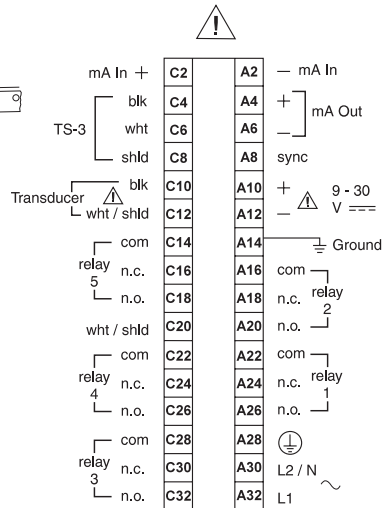

- Push the Hydro+ into the sub-rack until the HYDRO+ front cover is snug to the front rails.
- Tighten the 4 captivated screws to secure the HYDRO+ in place.

PANEL MOUNT

Voltage Selection

1. Set the voltage switches.

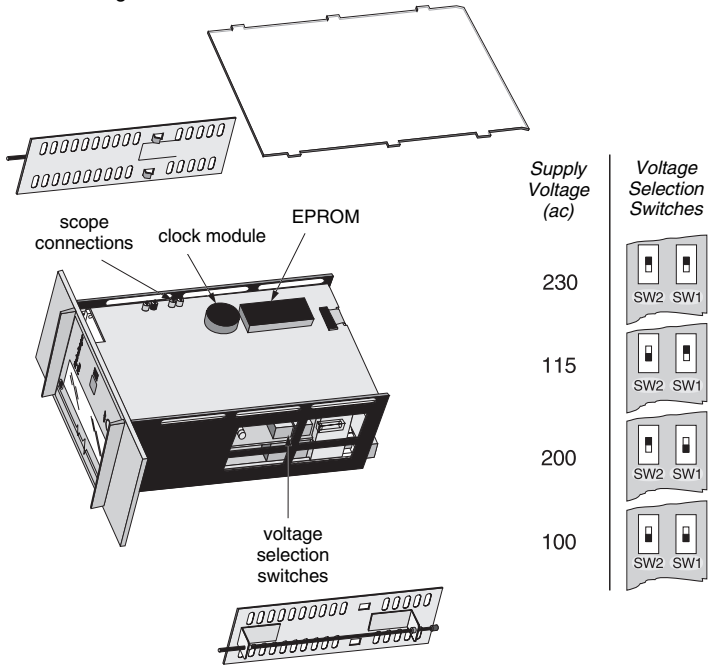

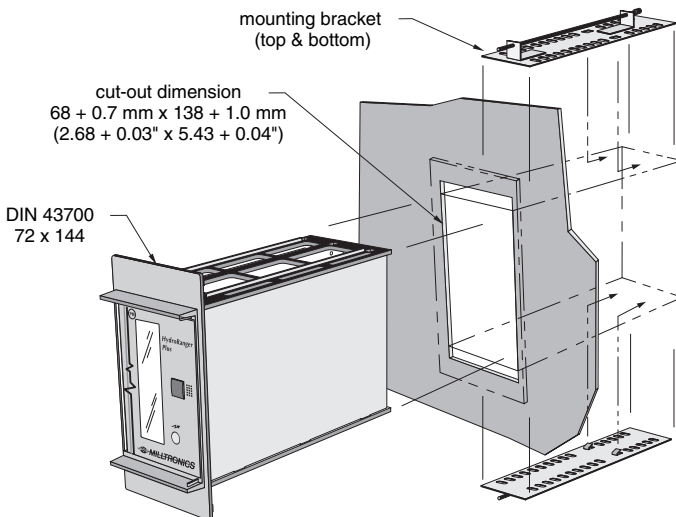

Installation

1. Slide the HYDRO+ through the panel cut-out.
2. Assemble mounting brackets to the HYDRO+ chassis by hooking them into the top and bottom

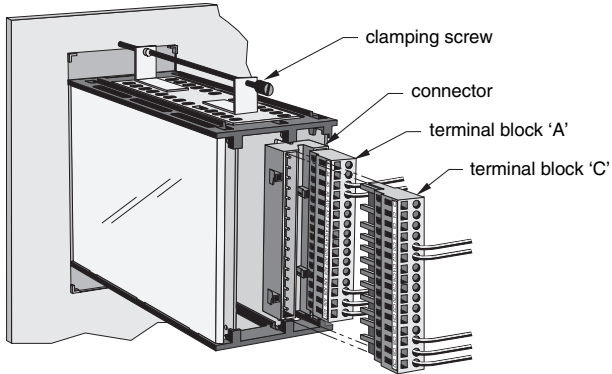

3. Tighten mounting bracket clamping screw (top & bottom)
4. Plug terminal blocks 'A' and 'C' into corresponding connector sockets, prewired by customer (refer to **INTERCONNECTION** \ Rack and Panel Mount).



 **All field wiring must have insulation suitable for at least 250 V .**

 **Hazardous voltage present on transducer terminals during operation.**

 **dc terminals shall be supplied from an SELV source in accordance with IEC 1010-1 Annex H.**

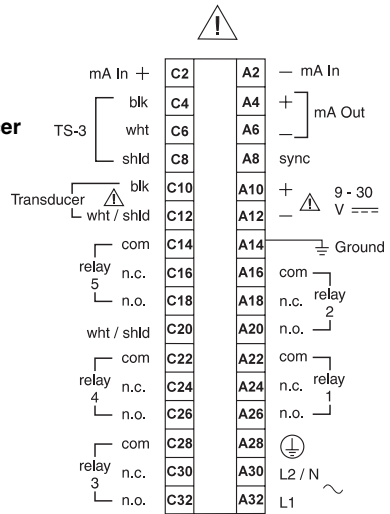

Use the tool provided to open terminals for insertion of wires.

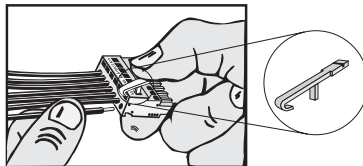

PROGRAMMER

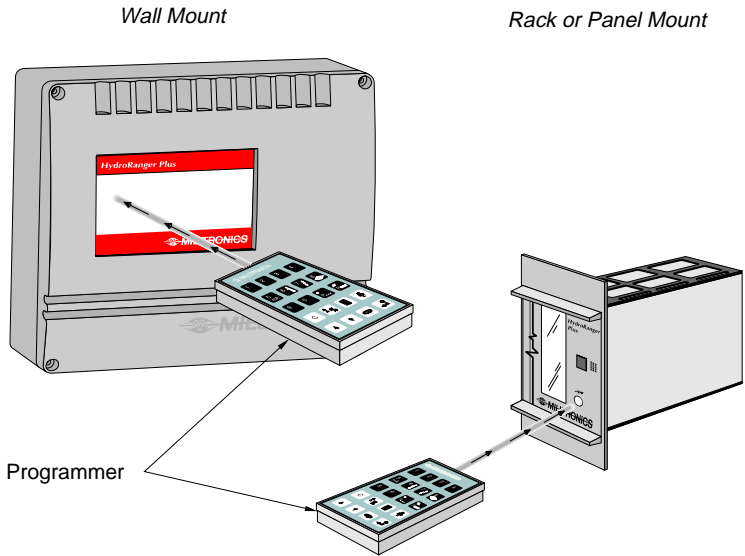

The hand held programmer is aimed at the receiver as depicted, while the keys are pressed.

CONVERTER (optional)

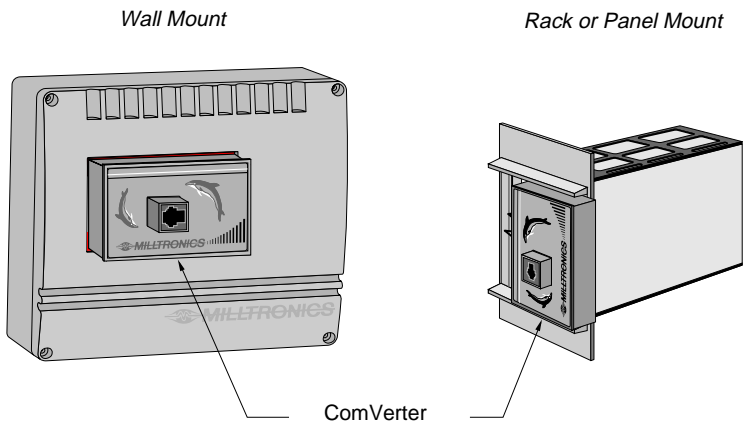

The ComVerter is pressed into the docking area as depicted and held in place by its pressure tabs.

Refer to Dolphin instruction manual, for interconnection details.

INTERCONNECTION

Verify all HYDRO+ system components have been installed in accordance with the associated product instruction manuals.

Connect all cable shields to the HYDRO+ shield connections. To avoid differential ground potentials, do not connect cable shields to ground (earth) elsewhere. Insulate (tape) cable shields at all shield junctions to prevent ground loops

SYSTEM DIAGRAM

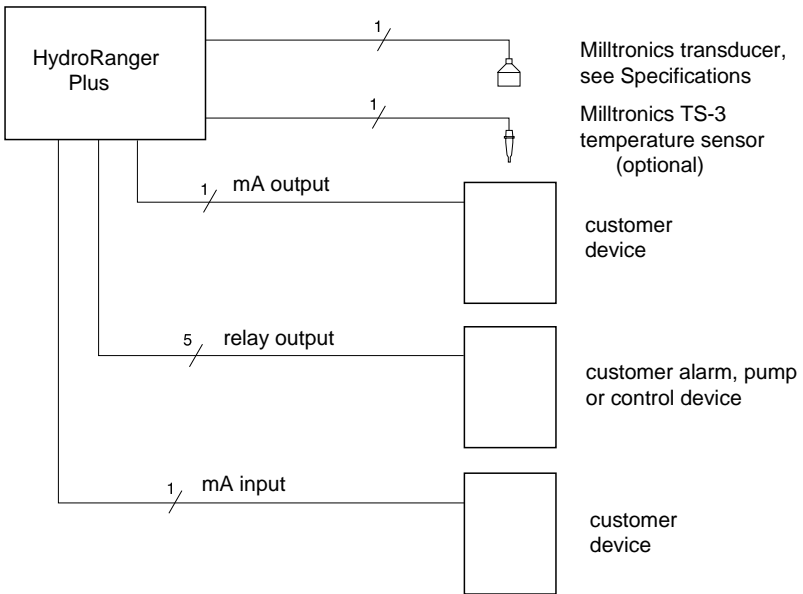

TRANSDUCER

Run the transducer cable in grounded metal conduit, separate from other wiring, (except TS-3 temperature sensor wiring, if applicable).

Typically, one transducer is used. However, if differential or average level monitoring is required, 2 transducers are used.

Wall Mount

Direct Connection

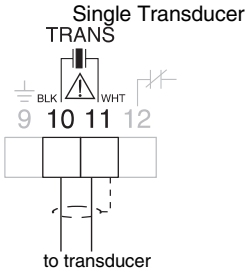

See transducer instructions for wiring details.

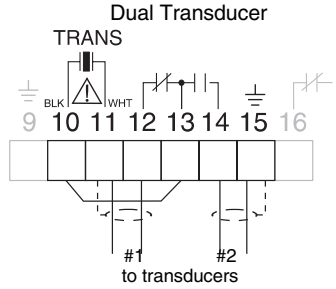

Coaxial Connection

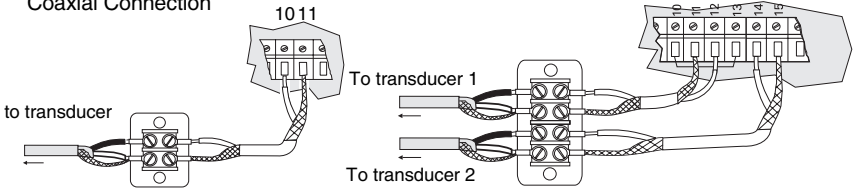

Rack or Panel Mount

Direct Connection

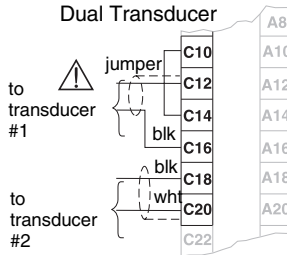
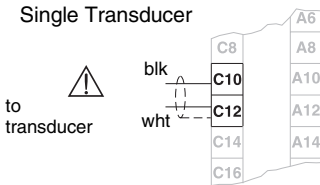

Coaxial Connection

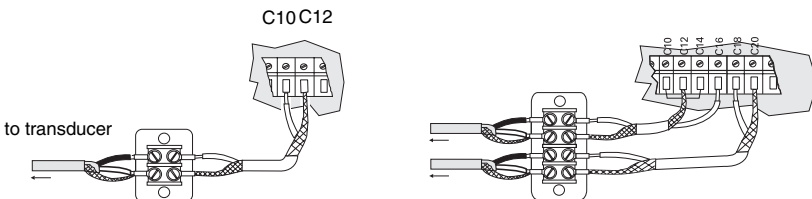

Hazardous voltage present on transducer terminals during operation.

TEMPERATURE SENSOR

All Milltronics Echomax and ST-H transducers have an internal temperature sensor. For optimum accuracy, use a separate TS-3 temperature sensor if:

- » the transducer is exposed to direct sunlight (or other radiant heat source),
- » the transducer connected is not an Echomax or ST-H, or
- » the transducer face and monitored surface temperature differs.
- » faster response to temperature changes are required.

(See **TECHNICAL REFERENCE** Sound Velocity).

Wall Mount

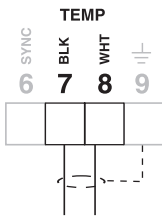

to optional TS-3

Rack or Panel Mount

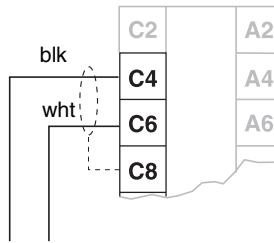

to optional TS-3

See TS-3 instructions for wiring detail.

Use a TS-3 temperature sensor only. Don't jumper unused TS-3 terminals.

RELAYS

Connect, alarm, pump, and/or control devices, to the HYDRO+ relays, after RUN mode operation is verified. (See **APPLICATIONS** for connection details).

Wall Mount

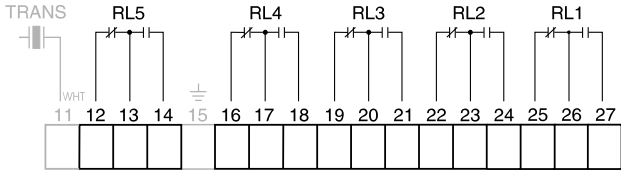

Rack or Panel Mount

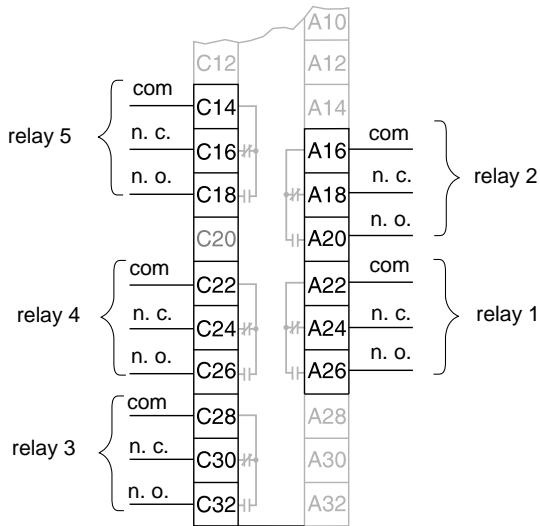

See **SPECIFICATIONS** for relay ratings.

Relays are shown in the alarm on / pump off / power off / de-energized position.

mA OUTPUT

The HYDRO+ mA output may be used to operate a variety of control/monitoring devices (1000 Ω max. load), providing 300 Vac continuous isolation.

Wall Mount

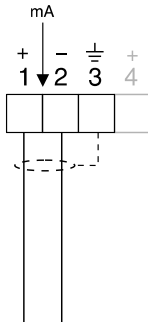

mA out

Rack or Panel Mount

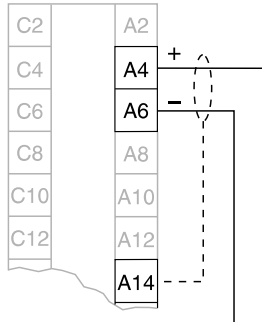

mA out

mA output to customer instrumentation, ground shield at one end only.

mA INPUT

If HYDRO+ features are required based upon measurements obtained from another level monitor, connect the level monitor mA output, to the HYDRO+ mA input terminals. Most HYDRO+ display, relay and mA output features may be used based upon the measurements provided by the auxiliary level monitor.

If this feature is used, refer to **PARAMETERS** Transducer (P004) and mA Input Parameters (P250, P251, and P252).

Wall Mount

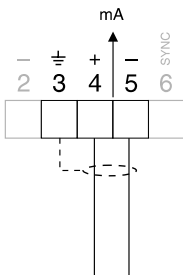

mA input

Rack or Panel Mount

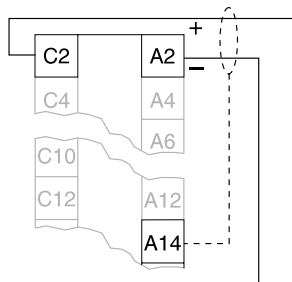

mA input

mA input proportional to level, ground shield at one end only.

LEVEL SYSTEM SYNCHRONIZATION

When multiple ultrasonic level monitors are installed within a single plant/facility, ensure the transducer cable(s) of each system are run in separate grounded metal conduits. Otherwise, synchronize the level monitors.

When level monitors are synchronized, no unit can transmit while another is awaiting echo reception.

To synchronize the HYDRO+ with a DPL+, XPL+, and/or another HYDRO+...

1. Mount the level monitors together in one cabinet.
2. Use a common power (mains) supply and ground (earth) for all units.
3. Interconnect the SYNC terminals of all level monitors.

Wall Mount

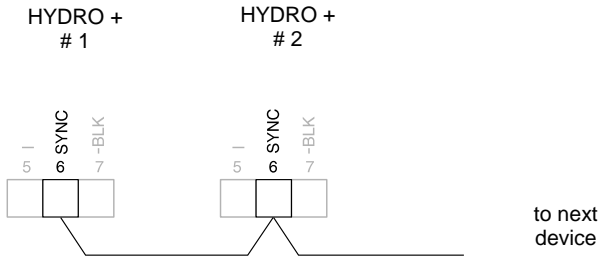

Rack or Panel Mount

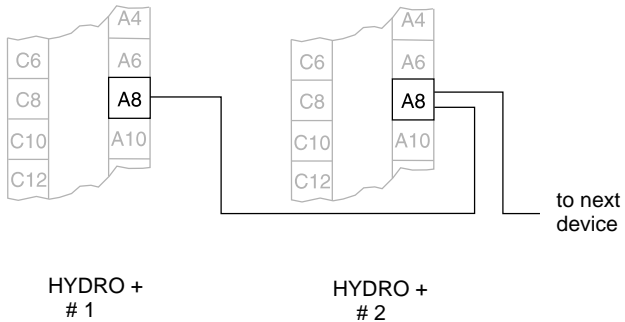

To synchronize the HYDRO+ with other Milltronics ultrasonic level monitors contact Milltronics or your local distributor.

POWER

The HYDRO+ uses 100, 115, 200, or 230 Vac or 9 to 30 Vdc power. If ac and dc power are supplied, the HYDRO+ draws power from the ac supply. In the event of an ac power interruption, the dc supply is used until ac power is restored.

IMPORTANT!

Before applying ac power (mains), ensure the correct voltage is selected!

**Never operate the HYDRO+ with the enclosure lid open,
or with the ground (earth) wire disconnected!**

**Before applying power to the HYDRO+ for the first time,
ensure any connected alarm/control equipment is disabled
until satisfactory system operation and performance is verified!**

AC SUPPLY WIRING

Wall Mount

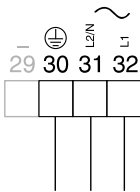

to ac supply

Rack or Panel Mount

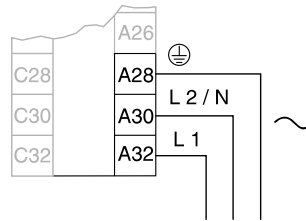

to ac supply

Set voltage selection switches per **INSTALLATION Mounting instructions.**

DC SUPPLY WIRING

Wall Mount

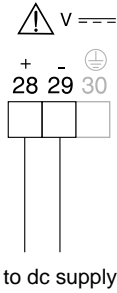

Rack or Panel Mount

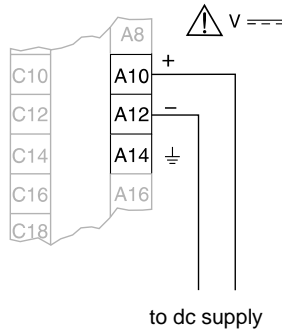

*Customer voltage supply 9 to 30 V dc.
Negative dc input (A12) is tied to earth (A14).*

The equipment must be protected by a 15 A fuse or circuit breaker in the building installation.

A circuit breaker or switch in the building installation, marked as the disconnect switch, shall be in close proximity to the equipment and within easy reach of the operator.



PROGRAMMING



Those not previously familiar with the HYDRO+, may wish to use the step by step initial start up procedure illustrated in the HYDRORANGER PLUS QUICK START GUIDE provided. Then, reference to the remainder of this instruction manual is only necessary if operation modification is required.

All programmable features are identified by a Parameter Number, which has a preset Parameter Value. Programming is accomplished by altering the Parameter Value of specific Parameter Numbers to obtain the RUN mode operation desired.

When applicable, the Point Number to be affected, must be identified before the Parameter Value is altered.

See **APPLICATIONS** for common HYDRO+ programming requirements. If more detailed parameter information is required, see **PARAMETERS**.

To enable the programmer interface of the HYDRO+ rack or panel mount version, press the  key on the front panel.

Program enable is confirmed by the  icon appearing in the display. To disable programming, press  again. Program disable is confirmed by absence of the  icon in the display. Disable all nearby units to avoid inadvertent programming.

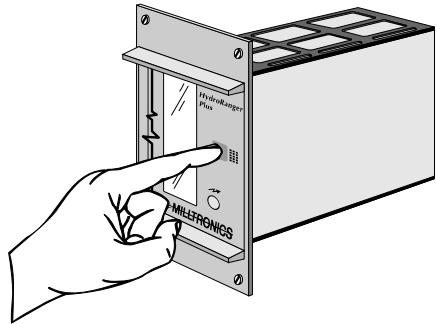

PROGRAM MODE ENTRY

Upon power application, RUN mode operation begins. To enter the program mode, hold the programmer within 0.3 m (1 ft) of the display window and,

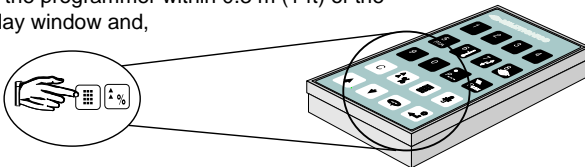

When the program mode is entered, all operating data is retained in memory.

Alarm relay status and mA output values are "held" at "last known" values and control relays are de-energized (unless affected by a parameter alteration or  is pressed), until the RUN mode is re-entered. The RUN mode is automatically re-entered if the HYDRO+ is left unattended in the program mode for an extended period (approximately 5 minutes).

DISPLAY

In the program mode, the Parameter Number, Parameter Value (and Point Number if applicable) may be viewed (as well as numerous other programming indicators).

Note that some indicators are specific to certain programming conditions and therefore, **all indicators are not displayed at any given time**.

e.g. The Transducer Point Number is only displayed when Differential or Average level monitoring is selected, (requiring programming for 2 transducers).

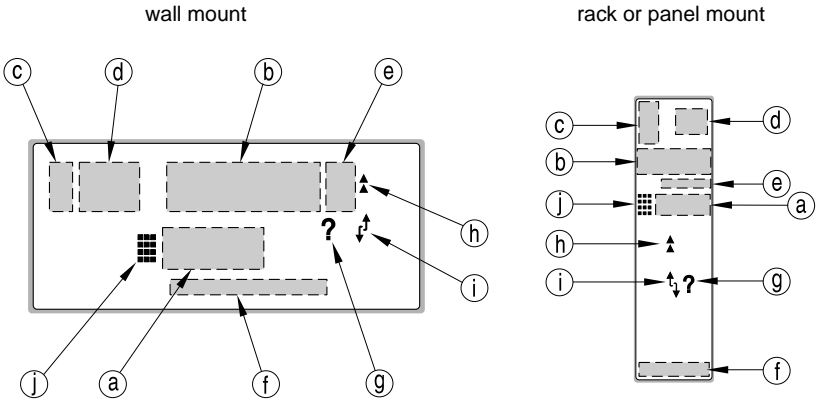

- a) Parameter Number (programmable feature accessed).
- b) Parameter Value (setting for the Parameter Number displayed).
- c) Point Type: $\frac{\perp}{\perp}$ transducer $\frac{\perp}{\perp}$ relay mA analog output
 \downarrow temperature \rightarrow index
- d) Point Number (of the Point Type accessed).
- e) Units (the Parameter Value is displayed in: m, cm, mm, ft, in, or %).
- f) Relay Number (programmed for RUN mode operation).
- g) Invalid Entry (the Parameter Value is questionable, are you sure?).
- h) Auxiliary Function (of the Parameter Number is accessed).
- i) Scroll Access Tag (the Parameter Number may be scroll accessed, \uparrow or \downarrow).
- j) Program Mode On (is accessed, operation has ceased).

Wall Mount: Program Mode accessed.

Rack or Panel Mount: Programmer interface enabled / Program Mode accessed.

KEYPAD

These instructions are for hand programmer (keypad) use. Use the instructions provided with the DOLPHIN interface package, if applicable.

Aim the HYDRO+ programmer infra-red transmitter at the HYDRO+ display within 0.3 m (1 ft) of the display window. In the program mode, use the HYDRO+ programmer keys to perform the following identified functions.

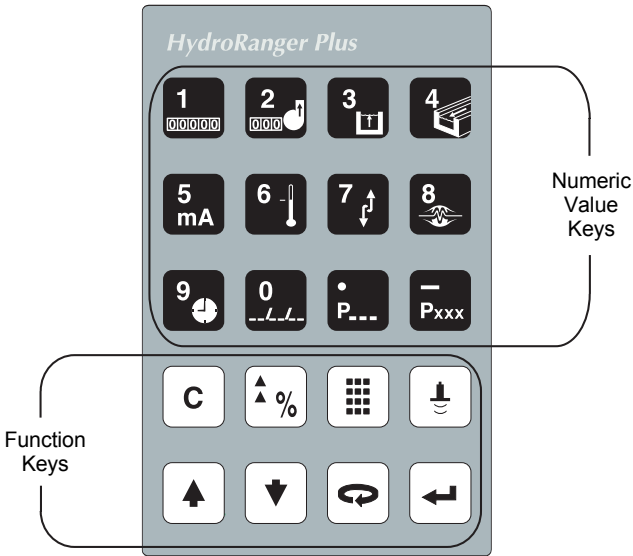

KEY NUMERIC ENTRIES

to input a numeric value into the display field accessed.

input a decimal point (moves TVT Pointers left).

input a negative value (moves TVT Pointers right).

FUNCTION



- shift access to another display field.
- delete the current field value (initiate a parameter reset).
- store the field values in memory (complete a parameter reset).
- switch to % or Units (access Auxiliary Parameter Function).
- increase the current field value.
- decrease the current field value.
- fire the transducer to take an ultrasonic measurement.
- enter the RUN mode.

PARAMETER VALUE ALTERATION

In the program mode...

1.  to underline the Parameter Number display field and...

a) key in the desired Parameter Number, (**direct access**) or...



b)  or  as required (**scroll access**).

(As preset, only Quick Start and altered parameters may be scroll accessed).

2. If the Point Number field is not displayed, proceed to step 3. Otherwise...

 to underline the Point Number display field and...

a) key in the desired Point Number, (**direct access**) or...

b)  or  as required, (**scroll access**).

To alter all Point Numbers at once, select Point Number 00.

3. With the Parameter Number (and Point Number if applicable) displayed...

key in the desired Parameter Value and,



Record Parameter Value alterations on the appropriate

PROGRAMMING CHARTS

If Parameter Value alteration is not permitted, access the Lock parameter (P000) and enter the security code, (see Programming Security).

SPECIAL PARAMETERS

Some Parameter Values are for display purposes only and cannot be operator altered. These are referred to as *view only* parameters.

In the **PARAMETERS** section of this instruction manual, View Only parameters are identified by a "(V)" beside the Parameter Number.

Many Parameter Values must be common for all Point Numbers. These are referred to as *global* parameters.

When a global parameter is accessed, the Point Number display automatically disappears. When a non-global parameter is accessed, the Point Number previously selected is displayed.

In the parameters sections of this manual, Global parameters are identified by a "(G)" beside the Parameter Number.

PARAMETER RESET FEATURES

To return an operator adjusted Parameter Value to the preset value, with the appropriate Parameter Number (and Point Number if applicable) displayed...



To reset all parameters to preset values, see **PARAMETERS** Master Reset (P999).

Perform a Master Reset (P999) to preset all parameters to "original" values before initial system installation, following an EPROM replacement, or whenever complete reprogramming is required.

PROGRAMMING SECURITY

All operator programming is retained in non-volatile memory, immune to power interruptions. When programming is complete, the programmer may be locked away to prevent inadvertent programming alteration. As well, the Lock (P000) parameter may be used.

OPERATION

With parameter alteration complete, the HYDRO+ may be put into operation.

Once put into operation (the RUN mode is entered), the HYDRO+ continues to operate unattended, indefinitely. However, numerous RUN mode features are available for acquiring specific operating information without removing the HYDRO+ from service.

RUN MODE ENTRY

The HYDRO+ automatically starts up in the RUN mode when power is applied.

After a programming alteration, do not use the HYDRO+ to operate alarms or controls until system programming and performance is verified.

To enter the RUN mode from the Program mode...



"----" is displayed briefly while the Reading is calculated and verified.

When complete, the Reading and other data is displayed; the mA output value and relay status are immediately updated accordingly.

(During "differential" or "average" Operation (P001 = 4 or 5), the display scrolls sequentially through Point Numbers 1, 2, and 3. Point Number 3 represents the difference between or average of Point Numbers 1 and 2).

If the HYDRO+ is left unattended in the Program mode for more than 5 minutes, the RUN mode is automatically entered.

DISPLAY

In the RUN mode, the following values and indicators may be observed.

Note that many indicators are specific to certain operating conditions and therefore, **all indicators are not displayed at any given time.**

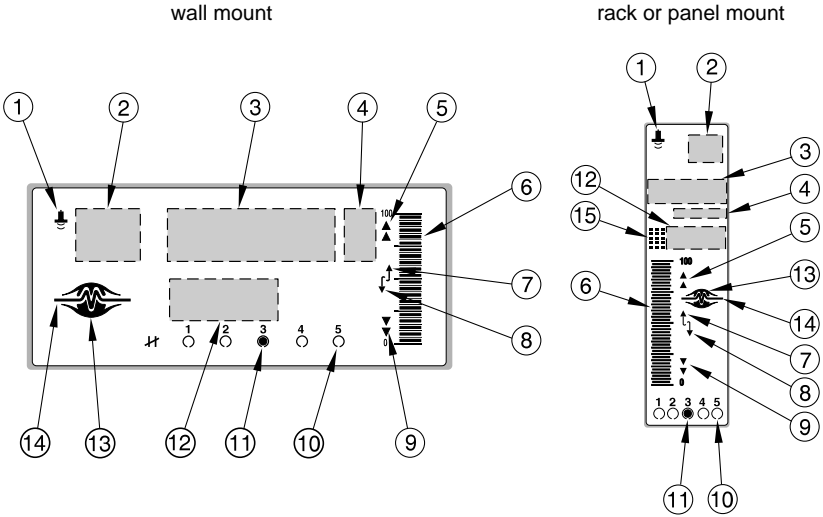

1. the current display pertains to a Transducer measurement.
2. Transducer Number 1, 2, or Result 3 (DPD or DPA operation only).
3. Reading resulting from Operation selected, (error message).
4. the Reading is in m, cm, mm, ft, in or %.
5. ▲ = HI alarm, ▲▲ = HI HI alarm.
6. Bar graph representation of level from 0 to 100% (absolute).
7. monitored surface is rising (nearer transducer).
8. monitored surface is falling (farther from transducer).
9. ▼ = LO alarm, ▼▼ = LO LO alarm.
10. ○ = Relay # programmed.
11. ● = pump, control, or alarm on.
12. Auxiliary Reading (see Keypad for selection).
13. = Normal operation.
14. = Failsafe operation.
15. programmer interface enable (rack or panel mount only)

KEYPAD

In the RUN mode, the following programmer keys perform the identified functions.

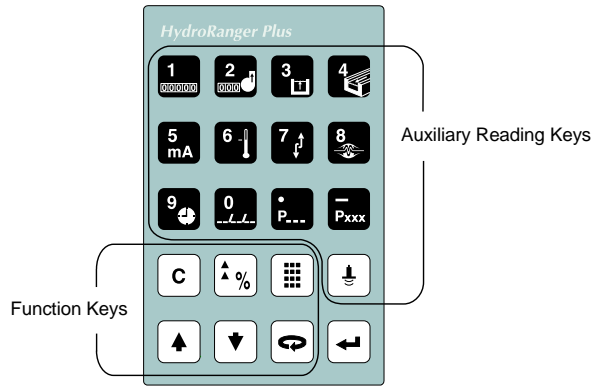

KEY

READING



"8 Digit Totalizer" ("OCM" or "PT" Operation, P001 = 6 or 7)

AUXILIARY READINGS



"Pump Running Time" (key in Pump Number, hold for Starts)



"Head" (OCM Operation, P001 = 6)



"Flow based on Head" (OCM Operation, P001 = 6)



"mA Output Value"



"Temperature" (air in °C)



"Rate of Change" (in Units/minute)



"Failsafe Time Left" (in percent)



"Time" (HH:MM, 24 hour format)



"Date" (MM:DD, of the current year)



"Parameter Value" (key in Parameter Number)



"Material Level" (may be altered via P731)



"Distance" (surface to transducer face)

FUNCTION



initiate program mode access (see )



toggle between Units and % (complete program mode access)



stop/start the Point Number auto display scroll



select the next Point Number (stop the display scroll)



select the previous Point Number (stop the display scroll)

SYSTEM PERFORMANCE EVALUATION

1.  to enter the RUN mode.

If a pump or control is ON, the corresponding relay is energized. If an alarm is ON, the relay is de-energized.







2.  to display the Reading in % (percent of Span, P007).

| OPERATION | LEVEL | SPACE or DISTANCE ¹ |
|-----------------|-----------|--------------------------------|
| Empty to Full = | 0 to 100% | 100 to 0% |

3.  to observe the current mA output value (Auxiliary Reading).

| OPERATION | LEVEL | SPACE or DISTANCE ¹ |
|-----------------|---------|--------------------------------|
| Empty to Full = | 4-20 mA | 20-4 mA |

4.  and then     or  to observe accumulated pump running hours² for pumps 1 to 5 respectively.

5.  and hold the     or  key (for 5 seconds) to observe the number of accumulated pump starts² for pump 1 to 5 respectively.

6.  to observe the *Failsafe Time Left* (in %) to failsafe activation.

When the Reading is updated, this value (Auxiliary Reading) resets to 100 and begins to decrease until the next valid measurement is made.

If the Failsafe Time Left reaches 0, "LOE" flashes in the Reading display.

¹ less than 0.3m (1 ft) cannot be reliably measured; a 0% Reading or 4 mA cannot be achieved during "distance" Operation.

² if the associated relay is programmed for a pump control function.

PERFORMANCE TEST RESULTS

Monitor system performance carefully, under all anticipated operating conditions.

- A. When the HYDRO+ performs exactly as required, programming is complete.
- B. If alternate Reading units, failsafe action, relay, or mA output operation is desired, proceed to **APPLICATIONS** and/or **PARAMETERS** as required.
- C. Should system performance not meet installation requirements, (or the "LOE" display persists after start up), proceed to **TROUBLESHOOTING**.

If all operating conditions cannot be observed during the System Performance Evaluation, refer to **PARAMETERS** Reading Measurement (P920). Perform a Reading Measurement simulation to verify programming.

Conduct a System Performance Evaluation following any installation modification or programming (parameter) alteration.

MAINTAINING OPERATION

With programming complete, record all parameter alterations.

- a) If the keypad programmer is used, enter the program mode and scroll access altered parameters (skipping parameters left at preset values). Record parameter alterations on the **PROGRAMMING CHARTS**.
- b) If the DOLPHIN interface package is used, refer to the associated instructions to record all operator programming.

For normal operation, return to the RUN mode. The HYDRO+ will perform reliably, requiring little or no maintenance.

Connect (or enable) process control/alarm equipment to the HYDRO+ only after satisfactory performance is verified for all possible operating conditions.

APPLICATIONS

The following examples illustrate how easily the HYDRO+ may be programmed to meet specific application requirements.

While your installation may not match these examples exactly, by reviewing the closest example (or combination of examples), the relationship between HYDRO+ features and your process measurement requirements may be more easily identified.

In every case, refer to General Application. This example defines the minimum programming required for any application. Then refer to the applicable "add on" examples for programming information specific to your application.

If additional parameter detail is required, (than provided in these examples), see **PARAMETERS** for complete parameter definitions.

Ensure all alarms and controls are disabled until all application programming is complete and satisfactory RUN mode performance is verified.

1. General Application (common programming to all applications).
2. Wet Well Control add on (combine with example 1).
3. Reservoir Control add on (combine with example 1).
4. Screen Rake Control add on (combine with example 1).
5. Penstock Control add on (combine with example 1).
6. General Alarm add on (combine with example 1).
7. Volume Calculation add on (combine with example 2 or 3).
8. Pumped Volume Calculation add on (combine with example 2 or 3 and 7).
9. OCM Flow Calculation add on (combine with example 1).
10. Failsafe Operation add on (combine with example 1 to 5).

GENERAL APPLICATION

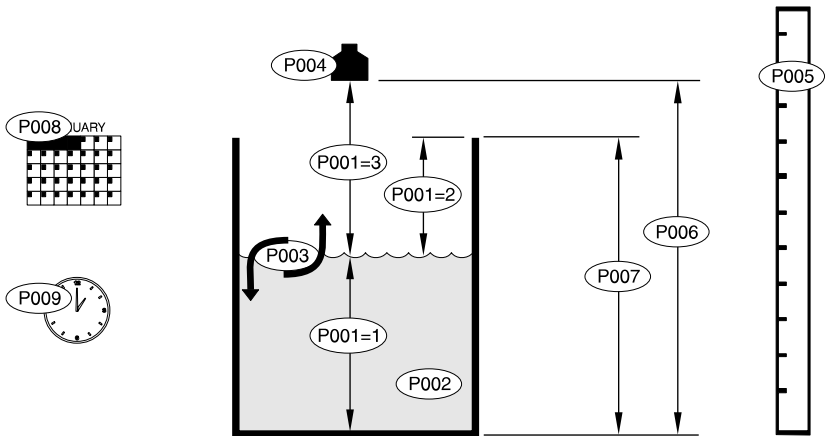

| PARAMETER | PRESET | OPERATION |
|-----------------|--------------|---|
| P001 Operation | 3 = distance | display Reading referenced to transducer face |
| P002 Material | 1 = liquid | anticipates echoes from a flat reflective surface |
| P003 Response | 2 = 1 m/min | typical liquid surface rate of change |
| P004 Transducer | 100 = ST-H | compensates for temperature variation |
| P005 Units | 1 = metres | displays all linear dimensions in metres |
| P006 Empty | 8.000 | 0% level bar graph reference point. |
| P007 Span | 8.000 | 100% level bar graph reference point. |
| P008 Date | YY.MM.DD | automatic leap year adjustment |
| P009 Time | HH.MM.SS | 24 hour format |

If power is applied before any programming is performed, the HYDRO+ starts running, using the parameter preset values. As long as the transducer connected has an internal temperature sensor and a maximum range of 15 m (50 ft) or less, the preset Transducer (P004) value is suitable for operator orientation with HYDRO+ operation.

If "Error" and the transducer terminal numbers are displayed, the transducer does not have an internal temperature sensor. See Transducer (P004) options.

The HYDRO+ operates like an ultrasonic tape measure, displaying distance from the transducer face to the surface monitored.

PARAMETER VALUE OPTIONS

Operation (P001) = 1 = "level", Full = 100% Reading = 20 mA (most common)
 2 = "space", Empty = 100% Reading = 20 mA (less common)
 3 = "distance", (references measurements to transducer face)
 4 = "DPD", (displays differential level, 2 transducers required)
 5 = "DPA", (displays average level, 2 transducers required)
 6 = "OCM", (calculates flowrate for head and total flow volume)
 7 = "PT", (calculates total pumped volume)

Material (P002) = 1 = "liquid", flat perpendicular reflective surface (most common)
 2 = "solid", angled rough reflective surface (for heaping solids)

Measurement Response (P003) = 1 = "0.1 m/min", very slow moving surface (less common)
 2 = "1.0 m/min", typical liquid surface (usual setting)
 3 = "10 m/min", very fast moving surface (less common)

Transducer (P004) = 0 = "out-of-service"
 1 = "ST-25"
 2 = "ST-50"
 100 = "ST-H"
 101 = "XCT-8" Enter the appropriate transducer type
 102 = "XPS-10"
 103 = "XCT-12"
 104 = "XPS-15"
 111 = "XKS-6"
 112 = "XRS-5"
 250 = "mA input"

Units (P005) = 1 = "metres"
 2 = "centimetres"
 3 = "millimetres" Enter the linear dimension units desired
 4 = "feet"
 5 = "inches"

Empty (P006) = "0.000" to "9999" Enter value in P005 Units

Span (P007) = "0.000" to "9999" Preset by P006, change if desired.

Date (P008) = "00:01:01" to "99:12:31" } (use  to key in ":", ".")

Time (P009) = "00:00:00" to "23:59:59"

With General Application programming complete, a System Performance Evaluation (see **OPERATION**) is recommended before proceeding to the following Application programming examples.

WET WELL CONTROL (Pump Down)

Typically, wet wells are used to temporarily hold storm and/or waste water. When the surface reaches a high level setpoint, the wet well is **pumped down**. The discharge goes on to another wet well or directly to the treatment facility.

The HYDRO+ provides wet well control with only minimal application programming. For the following example, we'll assume Empty (P006) was set from the transducer face to the wet well floor. (To monitor wet well overflow, see the note at the end of the OCM Application example).

(If the transducer cannot be located to avoid acoustic beam interference from the pumps, set Empty (P006) from the transducer face to the top of the pump(s).

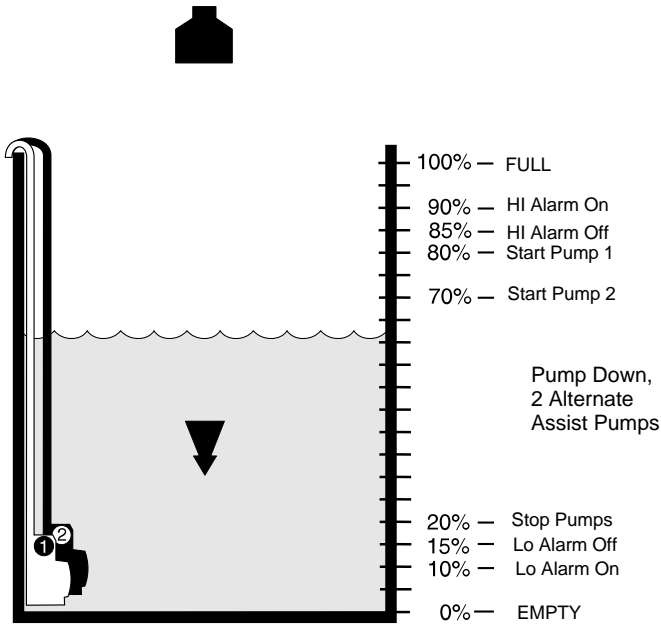

RELAY INTERCONNECTION

The relay contact illustrations adjacent to the HYDRO+ relay terminals are shown in the power off, de-energized, alarm on, pump off condition.

Connect the HYDRO+ relays as follows:

- RL1 to Pump 1 control (energized = pump on, de-energized = pump off)
- RL2 to Pump 2 control (energized = pump on, de-energized = pump off)
- RL3 to Hi Alarm indicator (energized = alarm off, de-energized = alarm on)
- RL4 to Lo Alarm indicator (energized = alarm off, de-energized = alarm on)
- RL5 not used

PROGRAMMING

Set Relay Set Up to "Wet Well 1" (P100=1) to preset relays as follows.

| PARAMETER | RL#1 | RL#2 | RL#3 | RL#4 | RL#5 |
|-----------------------|------|------|------|------|------|
| P111 Relay Function | 52 | 52 | 1 | 1 | 0 |
| P112 Relay A Setpoint | 70% | 80% | 90% | 10% | ---- |
| P113 Relay B Setpoint | 20% | 20% | 85% | 15% | ---- |

For one pump, set the RL#1 or RL#2 Relay Function to "off" (P111 = 0).

For 3 or more pumps (5 max.), choose the relay(s) to be used and program P111, P112 and P113 similar to RL# 1 and RL# 2 (but stagger the P112 setpoints).

OPERATION

By level (as indicated on bar graph) for 2 pumps...

1. Pump controls are operated as "alternate duty assist" (P111 = 52):

NORMAL OPERATION

- Pump 1 (lead pump) starts at 70%.
- Pump 1 stops at 20%, shift setpoints (lead) to next pump.

PEAK DEMAND OPERATION

- Pump 1 (lead pump) starts at 70%.
- Pump 2 (next pump) starts at 80%.
- Pump 1 and 2 stop at 20%, shift lead to next pump.



2. Alarms indicate control/pump malfunction (or excessive/insufficient capacity).

- HI alarm "on" at 90%, off at 85%.
- LO alarm "on" at 10%, off at 15%.
- Both alarms "on" = HYDRO+ power interruption.

3. Use the 4-20 mA output if desired...

- proportional to level if Operation = "level" (P001 = 1).
- inversely proportional to level if Operation = "space" (P001 = 2).

4. To view pump information in the RUN mode...

-  and then the pump # (to view the pump running hours total).
-  and hold the pump # (to view the number of pump starts total)

RESERVOIR CONTROL (Pump Up)

Typically, reservoirs are used to temporarily hold processed water. When the water surface reaches a low level setpoint, the reservoir is **pumped up**.

The HYDRO+ provides reservoir control with only minimal application programming. For the following example, we'll assume Empty (P006) was set from the transducer face to the reservoir bottom.

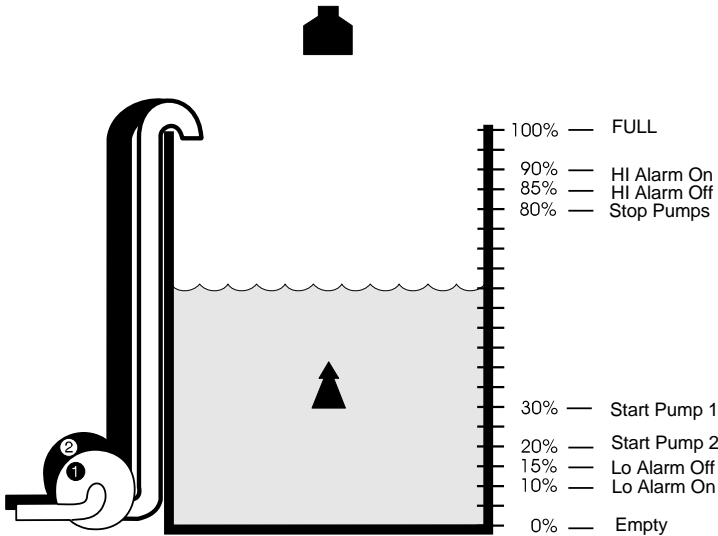

RELAY INTERCONNECTION

The relay contact illustrations adjacent to the HYDRO+ relay terminals are shown in the power off, de-energized, alarm on, pump off condition.

Connect the HYDRO+ relays as follows:

- RL1 to Pump 1 control (energized = pump on, de-energized = pump off)
- RL2 to Pump 2 control (energized = pump on, de-energized = pump off)
- RL3 to Hi Alarm indicator (energized = alarm off, de-energized = alarm on)
- RL4 to Lo Alarm indicator (energized = alarm off, de-energized = alarm on)
- RL5 not used

PROGRAMMING

Set Relay Set Up to "Reservoir 1" (P100=3) to preset relays as follows.

| PARAMETER | RL#1 | RL#2 | RL#3 | RL#4 | RL#5 |
|-----------------------|------|------|------|------|------|
| P111 Relay Function | 52 | 52 | 1 | 1 | 0 |
| P112 Relay A Setpoint | 30% | 20% | 90% | 10% | ---- |
| P113 Relay B Setpoint | 80% | 80% | 85% | 15% | ---- |

For one pump, set the RL#1 or RL#2 Relay Function to "off" (P111 = 0).

For 3 or more pumps (5 max.), choose the relay(s) to be used and program P111, P112 and P113 similar to RL# 1 and RL# 2 (but stagger the P112 setpoints).

OPERATION

By level (as indicated on bar graph) for 2 pumps...

1. Pump controls are operated as "alternate duty assist" (P111 = 52):

NORMAL OPERATION

- a) Pump 1 (lead pump) starts at 30%.
- b) Pump 1 stops at 80%, shift setpoints (lead) to next pump.

PEAK DEMAND OPERATION

- a) Pump 1 (lead pump) starts at 30%.
- b) Pump 2 (next pump) starts at 20%.
- c) Pump 1 and 2 stop at 80%, shift lead to next pump.

2. Alarms indicate control/pump malfunction (or excessive/insufficient capacity).

- a) HI alarm "on" at 90%, off at 85%.
- b) LO alarm "on" at 10%, off at 15%.
- c) Both alarms "on" = HYDRO+ power interruption

3. Use the 4-20 mA output if desired...

- a) proportional to level if Operation = "level" (P001 = 1).
- b) inversely proportional to level if Operation = "space" (P001 = 2).

4. To view pump information in the RUN mode...



and then the pump # (to view the pump running hours total)



and hold the pump # (to view the number of pump starts total)

RAKE CONTROL (Differential Level)

Typically a water purification process has a screen on the inlet side to filter solids from entering the process. Should the screen become blocked, and inflow sufficiently reduced, process efficiency can often be compromised.

The HYDRO+ provides screen rake control with only minimal application programming. For the following example, we'll assume Operation was set for "differential" (P001 = 4) and Empty (P006) was set from the transducer face to the channel bottom for both transducer 1 and transducer 2.

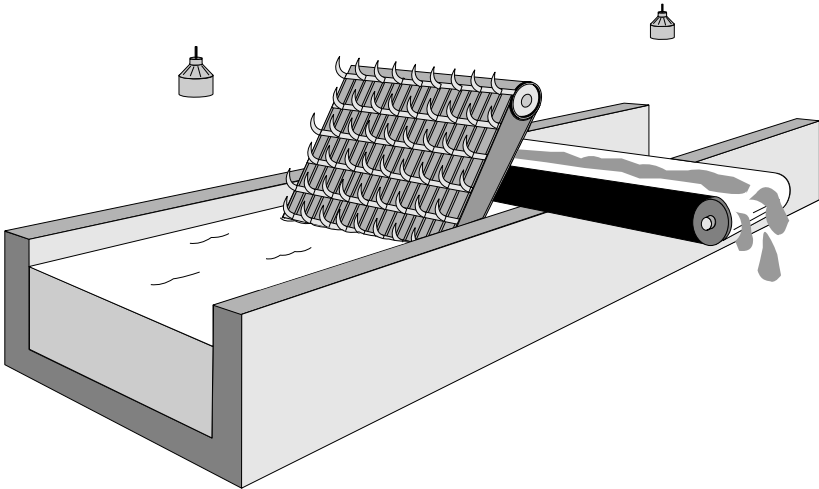

RAKE CONTROL

RELAY INTERCONNECTION

The relay contact illustrations adjacent to the HYDRO+ relay terminals are shown in the power off, de-energized, alarm on, control off condition.

Connect the HYDRO+ relays as follows:

- | | |
|---------------------------|--|
| RL1 to Rake control | (energized = rake on, de-energized = rake off) |
| RL2 to Hi Alarm (Point 1) | (energized = alarm off, de-energized = alarm on) |
| RL3 to Lo Alarm (Point 2) | (energized = alarm off, de-energized = alarm on) |
| RL4 to Hi Alarm (Point 3) | (energized = alarm off, de-energized = alarm on) |
| RL5 to transducers | See INSTALLATION Interconnection\Transducer |

PROGRAMMING

Set Relay Set Up to "Rake Control" (P100=5) to preset relays as follows.

| PARAMETER | RL#1 | RL#2 | RL#3 | RL#4 | RL#5 |
|-----------------------|------|------|------|------|------|
| P110 Relay Allocation | 3 | 1 | 2 | 3 | 1 |
| P111 Relay Function | 50 | 1 | 1 | 1 | 49 |
| P112 Relay A Setpoint | 80% | 90% | 10% | 90% | ---- |
| P113 Relay B Setpoint | 20% | 85% | 15% | 10% | ---- |

OPERATION

By level (as indicated by the Point Number bar graphs)...

1. The rake control:

- a) is turned "on" when Point # 3 = 80%.
- b) is turned "off" when Point # 3 = 20%.

2. Alarms indicate critical operating conditions.

- a) Hi Alarm (Point 1) = high channel inflow (on 90%, off 85%).
- b) Lo Alarm (Point 2) = low channel outflow (on 10%, off 15%).
- c) Hi Alarm (Point 3) = rake malfunction (on 90%, off 10%).
- d) All Alarms = HYDRO+ power interruption.

3. The 4-20 mA output is proportional to level on Point 1. If desired, set the mA Allocation for Point 2 (P202 = 2) or for differential Point 3 (P202 = 3).

PENSTOCK CONTROL

A *penstock* (motorized liquid flow control gate) is often used to control and maintain open channel flowrate. In some cases, penstock control is used to limit storm flow conditions through the channel by diverting excess (storm condition) flow to a temporary holding vessel.

To monitor open channel flow downstream from a penstock, see the note at the end of the OCM application example.

The HYDRO+ provides time step penstock control based on open channel level with only minimal application programming. For the following example, we'll assume Operation was set for "level" (P001 = 1) and Empty (P006) was set from the transducer face to the channel bottom.

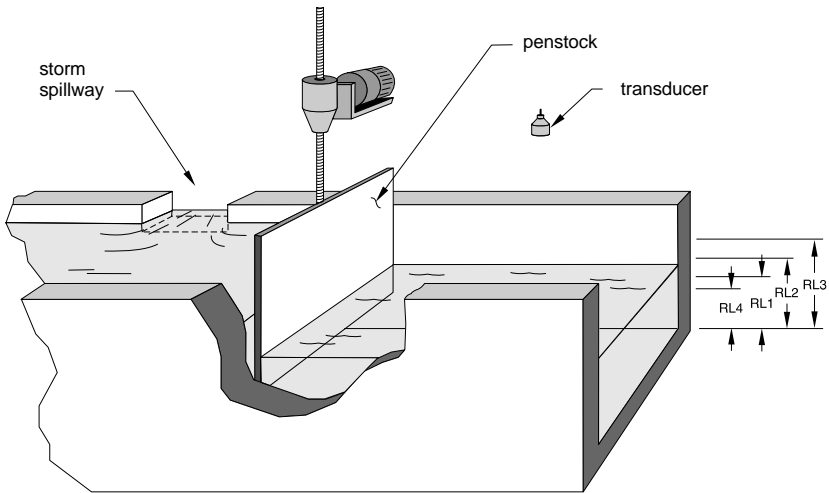

RELAY INTERCONNECTION

The relay contact illustrations adjacent to the HYDRO+ relay terminals are shown in the power off, de-energized, alarm on, control off condition.

Connect the HYDRO+ relays as follows:

- RL1 to "OPEN" control (energized = open penstock per P112,P114 and P115)
- RL2 to "CLOSE" control (energized = close penstock per P112, P114 and P115)
- RL3 to Hi Alarm (energized = alarm off, de-energized = alarm on)
- RL4 to Lo Alarm (energized = alarm off, de-energized = alarm on)
- RL5 not used

PROGRAMMING

GENERAL

P001 Operation = 1 (level)

P006 Empty = 1.7 m (e.g. Transducer to channel bottom)

P007 Span = 1.3 m (e.g. Channel bottom to highest head)

RELAYS

Set Relay Set Up to "off" (P100=0, preset) prior to relay programming.

| PARAMETER | RL#1 | RL#2 | RL#3 | RL#4 | RL#5 |
|-------------------------|------|------|------|------|------|
| P111 Relay Function | 63 | 63 | 1 | 1 | 0 |
| P112 Relay A Setpoint * | 45% | 55% | 65% | 35% | ---- |
| P113 Relay B Setpoint * | ---- | ---- | 60% | 40% | ---- |
| P114 Relay C Setpoint * | 0.1 | ---- | ---- | ---- | ---- |
| P115 Relay D Setpoint * | 0.02 | ---- | ---- | ---- | ---- |

* Relay Setpoints above are for illustration purposes only. Program Relay Setpoints as required to satisfy individual application requirements.

OPERATION

By level (as indicated by the bar graph)...

1. The Penstock is:

- driven more open for 0.1 minute at 45% level or less (RL1).
- driven more closed for 0.1 minute at 55% level or more (RL2).
- control operation limited (P115) to every 1 min, 12 secs (for stabilization).
- both controls are held "off" if the level is between 45.01% and 54.99%.

2. Alarms indicate critical operating conditions.

- Hi Alarm = close control malfunction (on 65%, off 60%)
- Lo Alarm = open control malfunction (on 35%, off 40%)
- Both Alarms = HYDRO+ power interruption

3. Use the 4-20 mA output if desired...

- proportional to level if Operation = "level" (P001 = 1).
- inversely proportional to level if Operation = "space" (P001 = 2).

GENERAL ALARMS

If relay operated controls are not required, the following general alarms may be added to the general application programming.

Alarms (similar to controls) are always based on level regardless of the Operation (P001) selected.

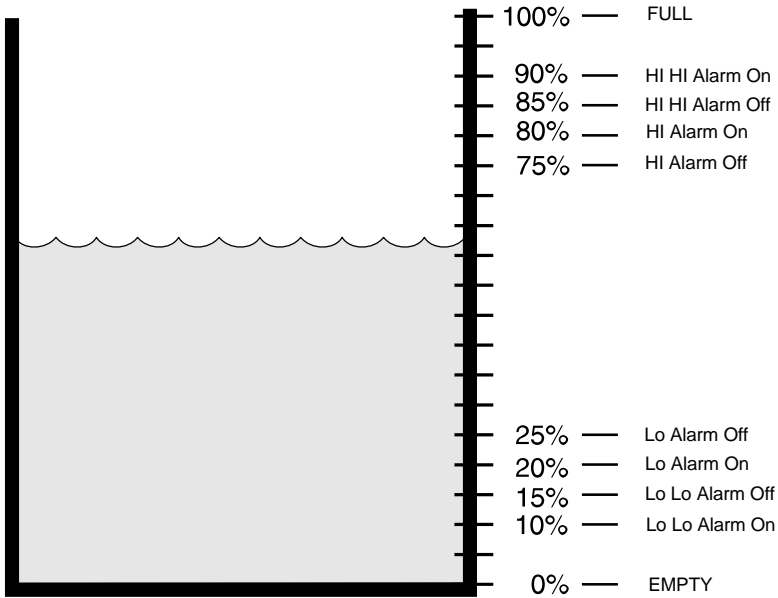

RELAY INTERCONNECTION

The relay contact illustrations adjacent to the HYDRO+ relay terminals are shown in the power off, de-energized, alarm on, control off condition.

Connect the HYDRO+ relays as follows:

RL1 to Hi Alarm (energized = alarm off, de-energized = alarm on)

RL2 to Lo Alarm (energized = alarm off, de-energized = alarm on)

RL3 to Hi Hi Alarm (energized = alarm off, de-energized = alarm on)

RL4 to Lo Lo Alarm (energized = alarm off, de-energized = alarm on)

RL5 not used

PROGRAMMING

RELAYS

Set Relay Set Up to "General Alarms" (P100 = 6) to preset relays as follows.

| PARAMETER | RL#1 | RL#2 | RL#3 | RL#4 | RL#5 |
|-----------------------|------|------|------|------|------|
| P111 Relay Function | 1 | 1 | 1 | 1 | 0 |
| P112 Relay A Setpoint | 80% | 20% | 90% | 10% | ---- |
| P113 Relay B Setpoint | 75% | 25% | 85% | 15% | ---- |

OPERATION

1. Alarms indicate critical operating conditions.

- a) Hi Alarm = high level (on 80%, off 75%).
- b) Lo Alarm = low level (on 20%, off 25%).
- c) Hi Hi Alarm = higher level (on 90%, off 85%).
- d) Lo Lo Alarm = lower level (on 10%, off 15%).

2. Use the 4-20 mA output if desired...

- a) proportional to level if Operation = "level" (P001 = 1).
- b) inversely proportional to level if Operation = "space" (P001 = 2).

OCM (Open Channel Monitor) Flow and Total Calculation

Typically, a water treatment process has a free flowing open channel on the inlet side. The channel is often restricted by a *PMD* (Primary Measuring Device) having a known head/flow relationship.

(See note at end of example for monitoring overflow from a wet well or flow downstream from a Penstock).

The HYDRO+ provides OCM flow and totalized flow calculation with only minimal application programming. Ensure Operation is set for "OCM" (P001 = 6) and Empty (P006) is set from the transducer face to the channel bottom at the distance from the PMD (if used) prescribed by the supplier.

RELAY INTERCONNECTION

The relay contact illustrations adjacent to the HYDRO+ relay terminals are shown in the power off, de-energized, alarm on, control off condition.

Connect the HYDRO+ relays as follows:

- RL1 As indicated by the alarm/control application example used.
- RL2 As indicated by the alarm/control application example used.
- RL3 As indicated by the alarm/control application example used.
- RL4 As indicated by the alarm/control application example used.
- RL5 to the remote totalizer (if used)

PROGRAMMING

OCM

- P600 PMD = 1 (preset, change to applicable PMD)
- P601 Flow Exponent = 2.50 (preset, change per PMD used, P600 = 1 only)
- P602 Flume Dimension D = 1 (preset, change per PMD used, P600 = 2 or 3)
- P603 Max Head = Span (preset, change to actual head at Max Flow)
- P604 Max Flow = 1000 (preset, change to flow at Max Head)
- P605 Zero Head = 0.000 (preset, change to zero head distance above Empty)
- P606 Time Units = 1 (preset, time portion of Max Flow)
- P607 Flow Decimal = 3 (e.g. display value to 3 decimal places)
- P610 Head Breakpoints = ---- (change to known flow heads; 32 max, P600 = 4 or 5)
- P611 Breakpoint Flowrates = ---- (change to flow at P610 heads; P600 = 4 or 5)
- P620 Low Flow Cutoff = 5% (preset, below this head, flow is not totalized)



LCD TOTALIZER

- P630 LCD Total Factor = 0 (preset, display in 1×10^0 Max Flow volume units)
- P633 LCD Total Decimal = 3 (e.g. display value to 3 decimal places)

REMOTE TOTALIZER (optional)

- P111 Relay Function = 40 (totalizer) for RL5
- P640 Relay Total Factor = 0 (preset, pulse every 1×10^0 (P604) volume units)
- P645 Relay On Time = 0.2 seconds (preset, adjust if necessary to suit totalizer)

OPERATION

1. Alarms and/or controls operate as programmed by other Application examples.
2. The totalizer relay energizes for (P645) seconds for every (P640) units.
3. The 4-20 mA output is proportional to flow.
4.  to display 8 digit total flow volume.
5.  to display head.
6.  to display flowrate.

To monitor the overflow (through a weir) from a wet well, program the HYDRO+ as indicated above, except program Empty (P006) and relays as illustrated in the Wet Well Control application example.

To monitor flow downstream from a Penstock, program the HYDRO+ as indicated above, except program relays as illustrated in the Penstock Control application example.

VOLUME CALCULATION

Sometimes, an indication of the liquid volume contained within a vessel, or remaining vessel capacity is required.

The HYDRO+ provides volume calculation with only minimal application programming. Ensure Empty (P006) is set from the transducer face to the vessel bottom and Span (P007) is set from the vessel bottom to the vessel top.

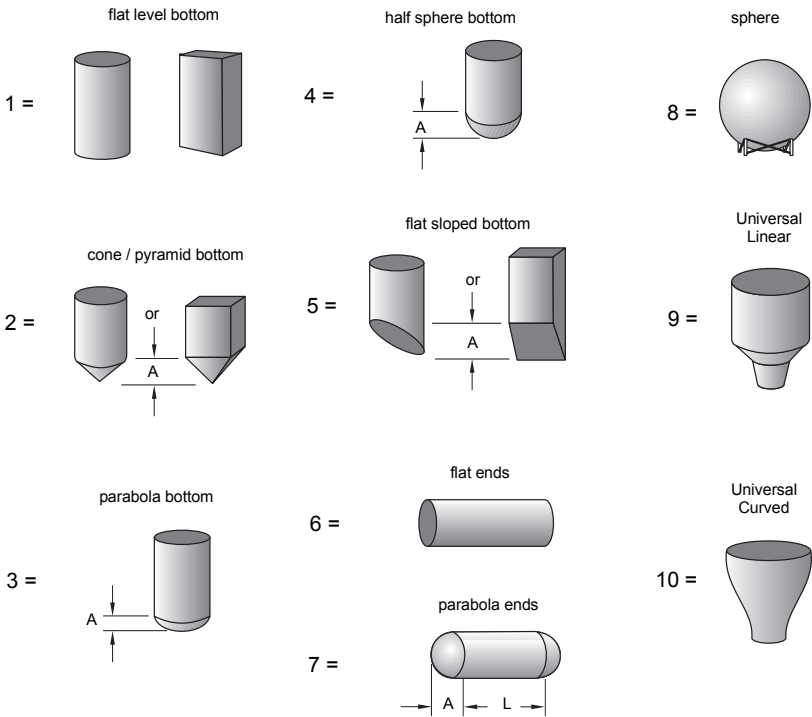

RELAY INTERCONNECTION

Connect the HYDRO+ relays as indicated by the alarm/control example used.

Ensure the surface monitored is controlled from coming within 0.3 m (1 ft) of the transducer face, (see **INSTALLATION** Transducer).

Volume calculation does not alter relay programming.

PROGRAMMING

VOLUME

- P050 Tank Shape = 0 (preset, change to applicable shape)
- P051 Max Volume = 100 (preset, display in %, other = volume of Span, P007).
- P052 Tank Dimension A (required for Tank Shapes: P050 = 2,3,4,5, or 7).
- P053 Tank Dimension L (required for Tank Shape P050 = 7)
- P054 Level Breakpoint (32 max., required for Tank Shapes: P050 = 9 or 10).
- P055 Breakpoint Volumes = volume associated with Level Breakpoints (P054).

OPERATION

1. Alarms and/or controls operate as programmed by other Application examples.
2. Use the 4-20 mA output if desired . . .
 - a) proportional to liquid volume if Operation = "level" (P001 = 1).
 - b) proportional to remaining capacity if Operation = "space" (P001 = 2).

PUMPED VOLUME TOTAL

Sometimes, an indication of the total liquid volume pumped from a wet well or into a reservoir is required.

The HYDRO+ provides total volume pumped calculation with only minimal application programming. Ensure Operation is set for "Pumped Total" (P001 = 7) and the Wet Well or Reservoir Control and Volume Calculation application programming is complete before proceeding.

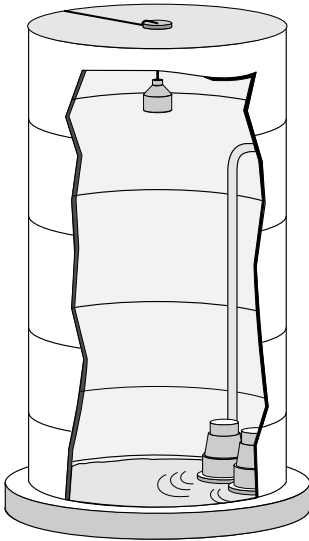

Remote Totalizer

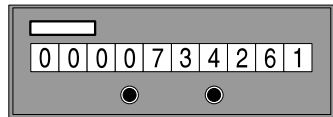

(not supplied)

RELAY INTERCONNECTION

The relay contact illustrations adjacent to the HYDRO+ relay terminals are shown in the power off, de-energized, alarm on, control off condition.

Connect the HYDRO+ relays as follows:

- RL1 As indicated by the alarm/control application example used.
- RL2 As indicated by the alarm/control application example used.
- RL3 As indicated by the alarm/control application example used.
- RL4 As indicated by the alarm/control application example used.
- RL5 To the remote totalizer (if used)

PROGRAMMING

LCD TOTALIZER

P622 In/Out Correction = 1 (preset, auto total inflow/discharge adjust)

P630 LCD Total Factor = 0 (preset, display total in Max Volume units)

P633 LCD Total Decimal = 3 (e.g. display 3 decimal places)



REMOTE TOTALIZER (optional)

P111 Relay Function = 40 (totalizer) for RL5

P640 Relay Total Factor = 0 (preset, pulse every 1×10^0 Max Volume units)

P645 Relay On Time = 0.2 seconds (preset, adjust if necessary to suit totalizer)

OPERATION

1. Alarms and/or controls operate as programmed by other Control Application programming examples.
2. The totalizer relay energizes for (P645) seconds for every (P640) volume units.
3. The 4-20 mA output is proportional to volume (per Volume Calculation).
4.  to display 8 digit total volume pumped value.
5. To view pump information in the RUN mode...
 -  and then the pump # (to view the pump running hours total)
 -  and hold the pump # (to view the number of pump starts total)

FAILSAFE OPERATION GENERAL



As preset, upon a loss of echo, the HYDRO+ Reading, alarm relays, and mA output are held at last "known" values and pump/control relays are de-energized, until a valid measurement is regained.

If desired, program the HYDRO+ to provide alternative display, relay and/or mA output operation under loss of echo conditions to provide failsafe operation.

PROGRAMMING

1. Enter the *Failsafe Material Level* (where alarms warn "unsafe" operation).

P071: HI = 100% bar graph level
 LO = 0% bar graph level
 HOLd = last level (preset)
 specific level = -50% to 150% of Span (P007) in Units or %.

}  and  or  to access.

2. Enter the Measurement Response for advance to the Failsafe Material Level.

P003 Response: 1 = 100 minute delay, advance at 0.1 metres/minute

 2 = 10 minute delay, advance at 1 metre/minute

 3 = 1 minute delay, advance at 10 metres/minute

3. To test failsafe operation (with the monitored surface still), disconnect the transducer cable and ensure alarms/controls activate.

For more failsafe programming and operation information,

see **PARAMETERS** P003,P070,P071,P072,P129,P219,P700,P701.

If any of these parameters are altered, retest Failsafe Operation.

WET WELL FAILSAFE

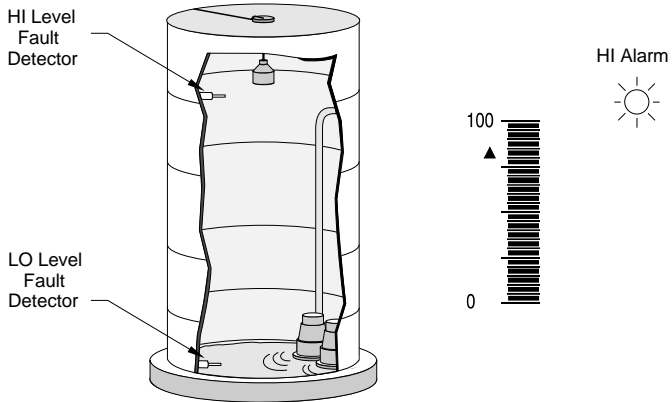

OPERATION

For this example we'll assume:

- P001 Operation is set to "level" (P001 = 1).
- P003 Measurement Response is set to "medium" (P003 = 2, preset).
- P006 Empty is set for 6.000 metres.
- P007 Span is set for 5.000 metres.
- P071 Failsafe Material Level is set for "HI".
- P100 Relay Set Up is set for Wet Well 1 (P100 = 1).
 - a) high alarm is to indicate failsafe operation.
 - b) lead pump starts (as preset) at 70% (3.5 m).
 - c) high alarm trips on (as preset) at 90% (4.5 m) and off at 85% (4.25 m).
 - d) normal wet well filling rate is 0.3 m/minute.
 - e) back up system takes over if level reaches 5.5 m.
 - f) at 9:15 am, the HYDRO+ transducer cable was accidentally cut.

- e.g.
- 09:15:00 am Echo lost at 2.2 m, pump(s) turn off, countdown begins
 - 09:25:00 am Failsafe activated, reported level advances at 1 m/min (P003).
 - 09:26:00 am backup control takes over, actual level = 5.5 m (and falling).
 - 09:27:18 am HI alarm trips on, reported level = 4.5 m.
 - 09:27:48 am HI alarm still on, reported level = 5 m.

APPLICATION ASSISTANCE

The preceding examples describe only a few ways in which the HYDRO+ can be applied to process measurement requirements.

The HYDRO+ can be used to monitor and/or activate alarm/control relays for almost any process (within the temperature, measurement range, and chemical immunity capabilities of the system) where a distance measurement or determination of presence vs. lack of presence of an object is desired.

By thoroughly reviewing the **PARAMETERS** sections, you may identify some interesting ways of using the HYDRO+ to monitor specific processes.

Milltronics has many years experience applying ultrasonic level measurement to a variety of processes in the mining, aggregate, lumber, grain, chemical, pulp and paper, water, and waste water industries.

If you encounter a difficulty applying the HYDRO+ to a process measurement requirement, or successfully apply the HYDRO+ to a "unique process" we may have never considered, contact Milltronics or your local distributor.

PARAMETERS

SECURITY PARAMETER (P000)



P000 (G) LOCK

Use this feature to secure all programming from inadvertent alteration.

Direct access (cannot be scroll accessed) this parameter after all programming is complete and enter any value (other than 1954) to activate the programming Lock.

When Lock is activated, the HYDRO+ may be switched from the RUN mode to the program mode and the value of any parameter may be viewed but not altered. To unLock the HYDRO+, direct access this parameter and enter the value "1954".

Normally, during a measurement simulation (see Measurement Parameters, P920 - P927), control relays remain de-energized. If desired, set Lock for "simulation controls" to have control relays functional during a simulation.

This parameter cannot be reset by   

values: 1954 = off (Parameter Value alteration permitted)

-1 = simulation controls

other = activated (programming secured)

QUICK START PARAMETERS (P001 TO P009)

P001 (G) OPERATION

Enter the type of RUN mode operation desired.

If "out-of-service" is entered, the transducer is not fired, alarm relay(s) energize, pump relay(s) de-energize, and mA output(s) assume the surface is at the Empty (P-006) value.

* If "DPD" or "DPA" is entered, 2 transducers are required, see **INSTALLATION** Transducer.

DPD = Point 3 = Point 1 - Point 2.

DPA = Point 3 = (Point 1 + Point 2) 2.

values: 0 = out-of-service

1 = level (display how full a vessel is)

2 = space (display how empty a vessel is)

3 = distance (preset, surface to transducer face distance)

4 = DPD (display the absolute difference between 2 levels)

5 = DPA (display the average of 2 levels)

6 = OCM (display flow in an open channel)

7 = PT (display total pumped volume)

P002 (G) MATERIAL

Enter the type of material monitored.

values: 1 = liquid or flat solid surface (preset)

2 = solid (heaping or angled away from transducer)

P003 MEASUREMENT RESPONSE

Enter the typical monitored surface rate of change in position.

This feature presets a variety of independently programmable parameters, substantially simplifying start up requirements.

If Failsafe, Rate, Measurement Verification, or Scanning parameters have been previously independently programmed, refer to

TECHNICAL REFERENCE Measurement Response before altering.

values: 1 = slow (0.1 m/min)

2 = medium (1 m/min) (preset)

3 = fast (10 m/min)

P004 (G) TRANSDUCER

Enter the type of transducer(s) connected to the HYDRO+.

values: 0 = Default after RESET - same as ST-25

| | | |
|------------|--------------|--------------|
| 1 = ST-25 | 101 = XCT-8 | 104 = XPS-15 |
| 2 = ST-50 | 102 = XPS-10 | 111 = XKS-6 |
| 100 = ST-H | 103 = XCT-12 | 112 = XRS-5 |

P005 (G) UNITS

Enter the units of measure desired for programming and/or display.

values: 1 = metres (m) (preset) 4 = feet (ft)

2 = centimetres (cm) 5 = inches (in)

3 = millimetres (mm)

P006 EMPTY

Enter the maximum transducer face to surface distance, in Units (P005).

For mA input applications (P004 = 250), set Empty value equal to Span (P007).

values: 0.000 to 9999 (preset to 8.000 m, or equivalent)

P007 SPAN

Enter the maximum surface distance from Empty (P006).

Span is automatically preset to 1.1 x the blanking value (P800) less than the Empty value, unless it is altered manually.

For "distance" Operation (P001=3), Span is preset to Empty (P006).

Enter a lower value if desired. If the automatic setting is not high enough, (see **INSTALLATION** Transducer). Always prevent the monitored surface from entering the blanking zone.

values: 0.000 to 9999

With the Quick Start Parameters altered as required, proceed to **OPERATION to identify / verify system performance**

P008 (G) DATE

Enter the current date in YY.MM.DD format.

values: 00.00.00 to 99.12.31

Year 2000 Compliance

The year is stored and displayed as a 2 digit number from 00 to 99. Year values less than 69 are 21st century (2000 – 2069). Year values greater than 70 are 20th century (1970 – 1999).

P009 (G) TIME

Enter the current time in HH.MM.SS (24 hour) format.

values: 00.00.00 to 23.59.59

VOLUME PARAMETERS (P050 to P055)

If Readings proportional to volume are desired, adjust the following parameters.

P050 TANK SHAPE

Enter the Tank Shape option that matches the vessel monitored.

If additional vessel dimension entry is required, the *associated parameters* (as indicated below) may be scroll accessed.

When Operation is "level" (P001 = 1), liquid (material) volume is calculated. Alternatively, when Operation is "space" (P001 = 2), remaining vessel capacity is calculated.

In the RUN mode, Readings are displayed in percent of (and mA outputs are proportional to) maximum volume. To convert Readings to volumetric units, see Max Volume (P051).

values: 0 = volume calculation not required (preset)

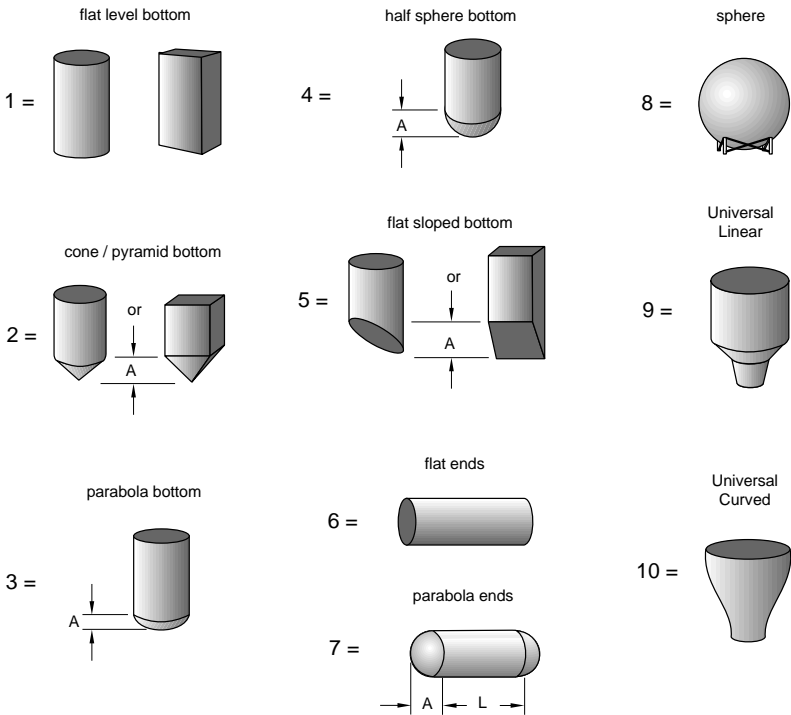

P051 MAX VOLUME

For Readings in volumetric units (rather than percent), enter the vessel volume between Empty (P006) and Span (P007).

e.g. 1) If volume = 3650 m³, enter 3650.

2) If volume = 267500 gallons, enter 267.5 (1000's of gallons).

values: 0.000 to 9999

P052 TANK DIMENSION A

Enter the height of the tank bottom if P050 = 2,3,4, or 5, or the length of one end section of the tank if P050 = 7, in Units (P005).

values: 0.000 to 9999

P053 TANK DIMENSION L

Enter the tank length (excluding both end sections) if P050 = 7.

values: 0.000 to 9999

P054 LEVEL BREAKPOINTS (Universal Volume Calculation)

Enter the level breakpoints* (where volume is known) if P050 = 9 or 10.

values: 0.000 to 9999

P055 BREAKPOINT VOLUMES (Universal Volume Calculation)

Enter the volume* corresponding to each Level Breakpoint entered.

values: 0.000 to 9999

* To enter a Level Breakpoint or Breakpoint Volume...

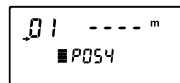

e.g. level breakpoint, breakpoint 1, value blank

Enter the desired value.

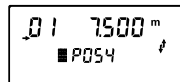
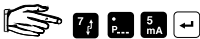

e.g. 7.5 m

Scroll (▲ or ▼) or direct access the desired Breakpoint.



e.g. breakpoint 2

Refer to **TECHNICAL REFERENCE** Volume Calculation for breakpoint value selection assistance.

READING PARAMETERS (P060 to P062)

Alter the following parameters to:

- a) change the number of decimal places displayed.
- b) convert the Reading to alternate units.
- c) reference measurements to other than Empty (P006) or Span (P007).

P060 DECIMAL POSITION

Enter the maximum number of Reading decimal places to be displayed.

In the RUN mode, the number of decimal places displayed is automatically adjusted (if necessary) to prevent the number of Reading digits from exceeding display capabilities.

This value is automatically altered when Units (P005) and/or Max Volume (P051) is altered.

values: 0 = no digits after the decimal point

1 = 1 digit after the decimal point

2 = 2 digits after the decimal point

3 = 3 digits after the decimal point

P061 CONVERT READING

Enter the value to multiply the Reading by, (before display).

This feature is preset to 1.000 (no conversion).

e.g. If the Reading is displayed in feet, to display in yards, enter 3.

Avoid entering a value that, when multiplied by the maximum current Reading, could exceed 5 digits before the Decimal Position.

values: -999 to 9999

P062 OFFSET READING

Enter the value to be added to the Reading, (before display).

This feature is preset to 0.000, (no offset).

e.g. To reference the current level to sea level, enter the distance in Units (P005), between Empty (P006) and sea level. (Enter a negative value if Empty is below sea level.)

**This feature affects the Reading only.
(Relays and mA outputs are not affected).**

values: -999 to 9999

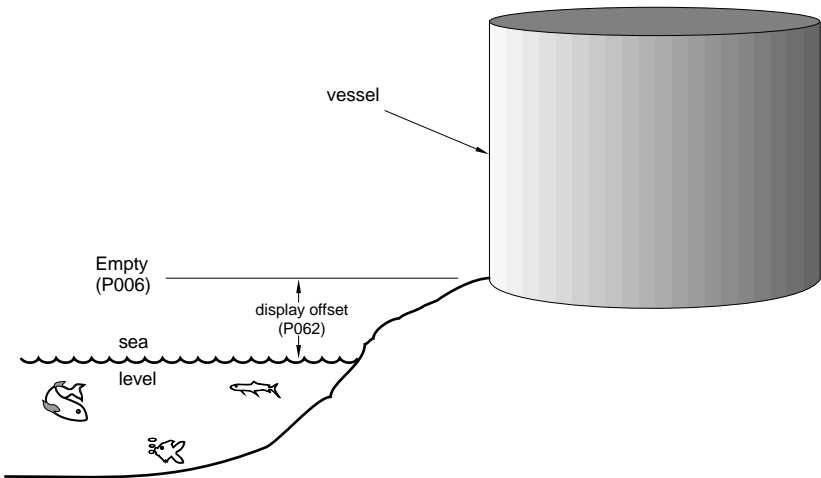

FAILSAFE PARAMETERS (P070 to P072)

As preset, if Failsafe Operation is activated, the display, alarm relays, and the mA output are held at their last "known" values, and control relays de-energize, until a valid measurement is regained.

To automatically operate alarms / controls under these conditions, alter the following parameters as required.

FAILSAFE OPERATION

If Failsafe Operation is not required, proceed to RELAY PARAMETERS.

If a difficulty occurs, the display, relay status, and mA outputs are held at their last "known" values and the Failsafe Timer is activated.

When a valid measurement is made before the Failsafe Timer (P070) expires, the HYDRO+ advances to the "new" material level, per the Max Empty / Fill Rate (P700 / P701, preset by Measurement Response, P003), and the timer resets.

If the timer expires, the HYDRO+ advances to the Failsafe Material Level (P071), per Failsafe Advance (P072), operating relays per Relay Failsafe (P129) and the mA output per mA Failsafe (P219).

When a valid measurement is made after the timer expires, the HYDRO+ advances to the "new" material level, per Failsafe Advance, and the timer resets.

If Failsafe Operation is activated frequently, see **TROUBLESHOOTING** .

P070 FAILSAFE TIMER

Enter the time to elapse (in minutes), upon a measurement or technical difficulty, before failsafe operation is activated.

If the timer expires due to a measurement difficulty, "LOE" flashes in the Reading display.

Technical difficulty messages ("Short", "OPen", and/or "Error") flash in the Reading display before the timer expires. The offending terminal connections are displayed in the Auxiliary Reading display.

Use a short duration Failsafe Timer value when fast moving surfaces are monitored, however avoid entering a value so short as to cause nuisance activation.

This value is automatically altered when Measurement Response (P003) is altered. See **TECHNICAL REFERENCE** Measurement Response.

values: 0.000 to 9999

P071 FAILSAFE MATERIAL LEVEL

Select the material level to be reported when the Failsafe Timer expires.

If "HOLd" (preset) is selected, the "last known" material level is held.

If "HI" is selected, the HYDRO+ advances to the Span (P007) level, per Failsafe Level Advance (P072).

If "LO" is selected, the HYDRO+ advances to the Empty (P006) level, per Failsafe Level Advance (P072).

Select the Failsafe Material Level based upon the relay and/or mA output operation required during failsafe operation.

e.g. 1) To de-energize a HI alarm relay, select "HI" (if P129 = "OFF").

e.g. 2) To force a low mA output, select "LO" (if P219 = "OFF").

Ensure relays and mA outputs used for Failsafe Operation are wired and programmed appropriately.

To select HI, LO, or HOLd...



to display the Auxiliary Function symbol,



or  as required to scroll access the desired option,



Alternatively, enter a specific Failsafe Material Level within -50 to 150% of Span (P007), in Units (P005), or % of Span.

values: -999 to 9999

P072 FAILSAFE LEVEL ADVANCE

Select the method for the HYDRO+ advance to (and from) the Failsafe Material Level.

When "restricted" (preset), the HYDRO+ advances to/from the Failsafe Material Level, as determined by Measurement Response (P003) or the Max Fill/Empty Rate (P700/P701) values entered.

Alternatively, when "immediate" is selected, the Failsafe Material Level (or "new" material level) is assumed immediately.

When "fast back" is selected, the Failsafe Level Advance is restricted, however the advance to the new material level is immediate.

values: 1 = restricted

2 = immediate

3 = fast back

RELAY PARAMETERS

Alter the following parameters as required.

STANDARD RELAY CONFIGURATIONS (P100)

These parameters set up Independent Relay Parameters to satisfy the most common relay operation requirements, requiring only one programming entry.

P100 (G) RELAY SET UP

Enter the Relay Set Up (if desired) to preset numerous relay parameters as required for common HYDRO+ applications.

If the Relay Set Up selected, exactly matches HYDRO+ relay operation requirements, no further relay programming is necessary.

If the Relay Set Up selected does not exactly match relay operation requirements, modify the Relay Set Up by independently programming the remaining relay parameters as required.

If completely independent relay programming is desired, enter "0" and proceed to Independent Relay Programming.

The "screen control" Relay Set Up may only be selected after "differential" Operation (P001 = 4) is selected.

Entering any Relay Set Up value automatically resets all relay programming to the Relay Set Up specified.

values: 0 = all relays off

- | | |
|---------------------------|---|
| 1 = <i>Wet Well 1</i> | (see APPLICATIONS Wet Well Control) |
| 2 = <i>Wet Well 2</i> | (similar to above except pump by rate)* |
| 3 = <i>Reservoir 1</i> | (see APPLICATIONS Reservoir Control) |
| 4 = <i>Reservoir 2</i> | (similar to above except pump by rate)* |
| 5 = <i>Screen Control</i> | (see APPLICATIONS Rake Control) |
| 6 = <i>General Alarms</i> | (see APPLICATIONS General Alarms) |

* Pumps are activated by rate of rise / fall rather than by specific level setpoints. See Rate Pump (P121).

INDEPENDENT RELAY PROGRAMMING (P110 and P111)

These parameters need only be accessed if the Relay Set Up (P100) selected does not exactly match the relay operation desired.

When any of the following Relay Parameters are accessed, the Point Type display changes to the Relay Symbol and the Relay Number (corresponding to the HYDRO+ terminals) is displayed in the Point Number field.

The HYDRO+ provides almost infinite versatility in relay programming capabilities. The following Relay Parameter descriptions are intended only for use to determine if a feature is required for a specific application and to define the values or range of values applicable.

For relay feature combination and interaction examples, see **APPLICATIONS** .

P110 RELAY ALLOCATION

This value may only be altered if Operation is set for *DPD* (Differential Level) or *DPA* (Average Level). (P001 = 4 or 5).

As preset, all relay operation pertains to Point Number 1, unless automatically altered by the Relay Set Up (P100) selection, if used.

Enter the Point Number(s) which the Relay Number (displayed) operation is to be based upon.

e.g. To allocate Relay 3 to Point 1, with Relay Number 3 displayed, enter 1.)

If the relay is allocated to more than one Point Number (1,2, and / or 3), any Point Number allocated can set the Relay Function (P111) "ON".

This value is reset if Relay Set Up (P100) is altered.

| | | |
|---------|--------------------------|----------------------|
| values: | 1 = Point # 1 | 2 = Point # 2 |
| | 1.2 = Point # 1 or 2 | 2.3 = Point # 2 or 3 |
| | 1.3 = Point # 1, 2, or 3 | 3 = Point # 3 |

P111 RELAY FUNCTION

Use this feature to define the operation of each relay required.

Relay Functions are divided into 4 categories

- » ALARM: the relay de-energizes to set the alarm "ON".
- » OPERATION: used for specific modes of Operation (P001).
- » PUMP: the relay energizes to set the pump "ON".
- » CONTROL: the relay energizes to set the control "ON".

Enter the Relay Function for the Relay Number displayed.

This value is reset if Relay Set Up (P100) is altered.

ALARM FUNCTIONS

HYDRO+ relays are de-energized to turn alarms "ON", and energized to turn alarms "OFF". If HYDRO+ power is interrupted, the alarm is activated (assuming the alarm is powered by an alternate source).





| FUNCTION | DESCRIPTION | SETPOINTS |
|-----------------|---|------------|
| Level | alarm at level setpoint | P112, P113 |
| In Bounds | alarm at level between setpoints | P112, P113 |
| Out of Bounds | alarm at level outside setpoints | P112, P113 |
| Rate of Change | alarm at level rise or fall setpoint | P112, P113 |
| Temperature | alarm at temperature setpoint | P112, P113 |
| LOE | alarm if Failsafe Timer (P070) expires | n/a |
| Cable | alarm if cable short or opened | n/a |
| Pump Efficiency | alarm if pump rate (P182) is less than reference (P180) | n/a |
| Time of Day | alarm on time of day | P114, P146 |
| Clock Failure | alarm on clock failure | n/a |

Level Alarms may be assigned the following designations:

| DESIGNATION | PURPOSE | DISPLAY INDICATOR | SETPOINTS |
|-------------|--------------|-------------------|-------------|
| (blank) | no indicator | none | as desired |
| L | Low Alarm | ▼ | P112 < P113 |
| LL | Lower Alarm | ▼ ▼ | P112 < P113 |
| H | High Alarm | ▲ | P112 > P113 |
| HH | Higher Alarm | ▲ ▲ | P112 > P113 |

To select a Level Alarm Designation (L,LL,H,HH or blank), enter the Level Relay Function, and then...

P111 RELAY FUNCTION (continued)

1.  to display the Auxiliary Function symbol,
2.  or , to scroll access the alarm designations and...
3.  when the desired designation is displayed.

ALARM OPERATION

Relay A / B Setpoints (P112 / P113) set the critical points (based on the Relay Function) where, in the RUN mode...

1. Alarm Indicators (if programmed) are switched "ON" and OFF"
2. Relays are "energized" and "de-energized"

For most Relay Functions, setpoint values represent material levels, entered in Units (P005) or percent of Span (P007) as referenced to Empty (P-006).

Temperature alarm values are entered in degrees Celsius (°C). Rate alarms are entered in Units / minute or percent of Span per minute. A positive value is entered for a filling rate alarm; negative for emptying.

| RELAY FUNCTION | SETPOINTS* | | RELAY ACTION | OCCURS WHEN |
|----------------|------------|------|--|--|
| | A | B | | |
| Level H or HH | 85% | 70% | de-energizes energizes | level rises to 85% level falls to 70% |
| Level L or LL | 15% | 30% | de-energizes energizes | level falls to 15% level rises to 30% |
| In Bounds▲ | 80% | 50% | de-energizes energizes de-energizes energizes | level falls to 78% level rises to 82% level rises to 52% level falls to 48% |
| Out of Bounds▲ | 80% | 50% | energizes de-energizes energizes de-energizes | level falls to 78% level rises to 82% level rises to 52% level falls to 48% |
| Rate of Change | +10% | +5% | de-energizes energizes | fill rate rise to 10%/min fill rate fall to 5%/min |
| | - 10% | - 5% | de-energizes energizes | empty rate rise to 10% / min empty rate fall to 5% / min |
| Temperature | 60 | 55 | de-energizes energizes | temperature rises to 60 °C temperature falls to 55 °C |
| | - 30 | - 25 | de-energizes energizes | temperature falls to -30 °C temperature rises to -25 °C |

* Values shown are for illustration purposes only. Enter values which apply to your particular installation.
 ▲ 2% factory set hysteresis, adjustable via P116

Important! Relay A / B Setpoint values cannot be exactly equal.

- | | |
|--|----------------------------------|
| values: 0 = off (relay is always de-energized) | 6 = LOE alarm |
| 1 = Level Alarm | 7 = Transducer Cable Fault Alarm |
| 2 = In Bounds Alarm | 8 = Pump Efficiency |
| 3 = Out of Bounds Alarm | 9 = Time of Day |
| 4 = Rate of Change Alarm | 10 = Clock Failure |
| 5 = Temperature Alarm | |

OPERATION FUNCTIONS

The following Relay Function options may be used only for specific modes of Operation (P001).

| FUNCTION | DESCRIPTION | SETPOINTS |
|--------------|--|-------------------|
| Totalizer | 1 contact closure per 1×10^Y units | P640/P645 |
| Flow Sampler | 1 contact closure per $X \times 10^Y$ units or time duration | P641-P645 P115 |
| Scanner | switches transducer inputs | n/a |

The Totalizer Function may be used if Operation is set for "OCM" (Open Channel Monitor) or "PT" (Pumped Volume Totalizer), (P001= 6 or 7).

The Flow Sampler function may be used if OCM Operation, (P001 = 6) is selected.

If DPD (differential level) or DPA (average level) Operation is selected, (P001 = 4 or 5), Relay Number 5 is automatically set for the Scanner function. See **INSTALLATION** Interconnection/Transducer for Transducer wiring details.

- values: 40 = Totalizer
 41 = Flow Sampler
 49 = Scanner

PUMP FUNCTIONS

HYDRO+ relays set for a Pump Function are energized to turn pump controls "ON" (start pump), and de-energized to turn pump controls "OFF" (stop pump). Therefore, if HYDRO+ power is interrupted, the pump(s) are turned "OFF".

Pumps are started and stopped at the critical Relay A / B Setpoint (P112 / P113) levels entered.

To *pump down* (reduce level) set $P112 > P113$.

To *pump up* (increase level) set $P112 < P113$

Use "duty assist" Pump Functions if all pumps are to assist each other (run at the same time, if necessary) to meet demand.

Use "duty backup" Pump Functions if a pump is to take over for another (stop the previous running pump), failing to meet demand (due to pump malfunction, intake blockage, etc.).

"Assist" and "Backup" Pump Functions cannot be mixed.

Use "fixed" Pump Functions to have setpoints fixed to the Relay Number for which they are altered. (Pumps don't rotate lead and lag).

Use "alternate" Pump Functions to have setpoints sequentially rotated between pumps (each time all pumps are stopped) for equal pump use.

Use "service ratio" Pump Functions to have setpoints re-assigned to pumps to meet the Pump Service Ratio (P122) predetermined usage.

Use the "fofo" Pump Function to have setpoints reassigned so the first pump on is the first pump off, regardless of setpoint entry order.

values: 50 = fixed duty assist

51 = fixed duty backup

52 = alternate duty assist

53 = alternate duty backup

54 = service ratio duty assist

55 = service ratio duty backup

56 = fofo alternate duty assist

CONTROL FUNCTIONS

HYDRO+ relays are energized to turn controls "ON", and de-energized to turn controls "OFF". Therefore, if HYDRO+ power is interrupted, the control is "OFF".

| FUNCTION | DESCRIPTION | SETPOINTS |
|-------------|--------------------------------------|------------------|
| Time | relay operation on elapsed time | P114, P115 |
| Storm | relay operation on storm conditions | P150-P152 |
| Aeration | timed relay operation if pumps off | P114, P115 |
| Penstock | timed relay operation based on level | P112, P114, P115 |
| Flush Valve | timed relay operation on pump cycles | P170-P173 |

Use the "Time Control" Relay Function to activate a device based upon elapsed time.

e.g. Timed rake control to keep ram lubricated if idle for long periods.

Use the "Storm Control" Relay Function to activate a device based upon high levels associated with storm conditions.

e.g. Open gate (valve) to divert storm overflow into a holding vessel.

Use the "Aeration Control" Relay Function to activate a device based upon elapsed time since all pumps have been "OFF".

e.g. Timed fresh air introduction to reduce gas concentration.

Use the "Penstock Control" Relay Function (HYDRO+ relays RL1 and RL2 only) to activate a device for a specific time if level is outside a specified band.

e.g. Maintain constant level by time step adjusting upstream Penstock based on downstream head.

Use the "Flush Valve" Relay Function to activate a device for a specific time based upon pump cycle frequency.

e.g. Re-circulate into wet well periodically to dilute bottom solids.

- values:
- 60 = Time Control
 - 61 = Storm Control
 - 62 = Aeration Control
 - 63 = Penstock Control
 - 64 = Flush Valve

INDEPENDENT RELAY SETPOINTS (P112 to P115)

Independent Relay Setpoints define the critical condition(s) which will cause a relay to operate based upon the Relay Function (P111) selected.

RELAY A and B SETPOINTS

Relay Functions requiring continuous relay operation until a critical condition subsides use Relay A and B Setpoints (P112 and P113). Typically, Relay A and B setpoint values represent a level, entered in Units (P005) or % of Span (P007) as referenced to Empty (P-006). (Ensure the % symbol is displayed before attempting to enter a % of Span value, see **PROGRAMMING** Keypad).

Temperature alarm values are entered in degrees Celsius (°C).

Rate alarms are entered in Units per minute or percent of Span per minute. A positive value is entered for a filling rate alarm; negative for emptying.

These values are reset when Relay Set Up (P100) is altered.

P112 RELAY A SETPOINT

Enter the critical point for the Relay Function (P111) to be "ON".

values: -999 to 9999

P113 RELAY B SETPOINT

Enter the critical point for the Relay Function (P111) to be "OFF".

values: -999 to 9999

RELAY C and D SETPOINTS

These setpoints are for Relay Functions requiring timed relay operation.

P114 RELAY C SETPOINT

Enter the length of time the relay is to be energized (ON Duration). This value (in minutes) must be less than the Relay D Setpoint value.

values: 0.000 to 9999

P115 RELAY D SETPOINT

Enter the length of time desired for the Relay Cycle Period. This value (in hours) must be greater than the Relay C Setpoint value.

Relay Cycle Period = ON Duration + OFF Duration.

values: 0.000 to 9999

P 116 BOUND ALARM HYSTERISIS

For 'in bounds' and 'out of bounds' Relay Functions (P111 = 2 and 3 respectively), a hysteresis or dead band prevents relay chatter due to material level fluctuations at the upper or lower setpoint.

Enter hysteresis in % of span or units of P005. (Factory set at 2%).

The hysteresis value is applied above and below the upper and lower bound setpoints.

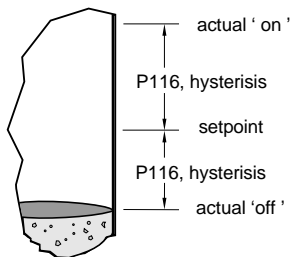

e.g. in bounds, lower setpoint

PUMP SETPOINT MODIFIERS (P121 and P122)

P121 (G) RATE PUMP

Use this feature when more than one relay is set for a "Pump" Relay Function (P111), to start pumps by rate rather than by level.

During operation, when all pumps are OFF and the level reaches the Relay A Setpoint, the first pump is turned ON.

If more than one relay (5 max.) is set for a "pump" Relay Function, pumps will be started in sequence until the level changes at a rate greater than the corresponding Filling (pump up)/Emptying (pump down) Indicator (P702 / P703) value, or until all pumps are running (which ever occurs first).

(If the surface is within 5% of Span (P007) from the Relay B Setpoint, and rate falls below the P702 / P703 value, the pump is held "OFF").

This feature is preset to " on " if Relay Set Up is set for " Wet Well 2 " or " Reservoir 2 " (P100 = 2 or 4) and " off " for any other Relay Set Up value.

values: 0 = off (pump by level)
1 = on (pump by rate)

P122 PUMP SERVICE RATIO

Use this feature to predetermine pump usage if a "Pump Service Ratio" Relay Function (P111 = 54 or 55) is selected.

When more than one pump is assigned a Pump Service Ratio value (in any time units) and a pump start is required (Relay A Setpoint, P112), the pump with the least running hours (with respect to the assigned ratio values) is started.

Conversely, when a pump stop is required (Relay B Setpoint (P113), the pump with the most running hours (as compared to the assigned ratio values), stops.

values: 0.000 to 9999

INDEPENDENT FAILSAFE RELAYS (P129)

P129 RELAY FAILSAFE

Use this feature for relay failsafe operation independent from the Failsafe Material Level (P070).

Select: "OFF" for relay response to the Failsafe Material Level (P701).

"HOLd" for "last known" relay state retention.





"dE" to have the relay de-energize immediately.

"En" to have the relay energize immediately.

When the Relay Function (P111) is set for:

- a) "alarm", this feature is preset to "OFF".
- b) "control", this feature is preset to "dE".

To select an independent Relay Failsafe option value:

1.  , to display to the Auxiliary Function symbol,
2.  or  , to scroll access the failsafe options.
3.  , with the desired option displayed.

values: "OFF"

"HOLd"

"dE"

"En"

PUMP CONTROL MODIFIERS (P130 to P134 and P136)

P130 (G) RUN ON INTERVAL

Use this feature to periodically have pumps continue running for a specified time (Run On Duration, P131) to discharge sediment.

Sets the period, in hours, during which a pump run-on may occur (must have a value greater than 0.000 to function).

values: 0.001 to 9999 (preset = 0.000)

Note:

This feature is not available when using DPD (Differential Level, P001=4).

P131 (G) RUN ON DURATION

Enter the duration of pump run-on, in seconds. Only one run-on is allowed per interval (P130).

Choose a value long enough to clean out the vessel bottom, yet short enough not to run the pump dry (if to do so may damage the pump).

values: 0.0 to 9999 (preset = 0.0)

P132 (G) START DELAY

Use this feature to reduce the power (mains) surge that would be generated if multiple pumps were to start simultaneously.

Enter the time to elapse (in seconds) after a pump has started before the next pump is permitted to start (if called for).

values: 0.0 to 9999 (preset = 10 seconds)

P133 (G) POWER RESUMPTION DELAY

Use this feature to reduce the power (mains) surge that would occur if pumps were to start immediately on power resumption.

Enter the time to elapse after power resumption (following a power interruption) before pumps are permitted to start.

values: 0.0 to 9999 (preset = 10 seconds).

P134 PUMP EXERCISING

Use this feature to reduce idle pump corrosion/sediment build up.

If a pump remains idle for the time (in hours) specified by the Relay D Setpoint (P115) value entered, the pump runs for the time specified by the Relay C Setpoint (P114) value.

values: 0 = off (preset)

1 = on (exercise pumps per P114 / P115)

P136 (G) WALL CLING REDUCTION

Use this feature to reduce material (fat, soap etc.) concentration on the vessel walls at the "normal" level.

This feature adjusts the Relay A / B Setpoints (P112 / P113) within the band specified, as follows:

- » For "pump down" applications (Relay A Setpoint > Relay B Setpoint), the Relay A / B Setpoint values are randomly varied within the band specified (lower than Relay A Setpoint, higher than Relay B Setpoint).
- » For "pump up" applications (Relay A Setpoint < Relay B Setpoint), the Relay A / B Setpoint values are randomly varied within the band specified (higher than Relay A Setpoint, lower than Relay B Setpoint).

Enter the band of Relay A / B Setpoint value variation desired.

values: 0.000 to 9999 (preset = 0.000)

P137 PUMP GROUP

Use this feature to group pumps (relay points 1 - 5) into group 1 or 2.

The feature is applied to pump rotation* and occurs independently within each group.

values: 1 = group 1 (preset)

2 = group 2

* P111 = 51, 52, or 53 (fixed duty back up, alternate duty assist or alternate duty back up, respectively)

PUMP ENERGY COST REDUCTION (P140 to P145)

These features enable a single pumping station (or multiple pumping stations in series) to be emptied/filled as required, immediately prior to the high energy cost period. The pump start/pump stop setpoints may also be modified to reduce pump running time during this period.

A maximum of ten energy periods can be programmed by indexing the peak start (P141) and end (P142) for periods 1 through 10 and entering the desired times.

P140 (G) ENERGY SAVING

Use this feature to maximize pump use during low energy cost periods, and limit use during high energy cost periods.

values: 0 = off (preset)

1 = on (do not pump during peak energy cost, if possible).

P141 (G) PEAK START TIME

Enter the time of day when high energy costs (to be avoided) start.

This value, in conjunction with Peak End Time, defines the high energy cost period.

values*: HH.MM format (preset = 00:00)

P142 (G) PEAK END TIME

Enter the time of day when high energy costs (to be avoided) end.

values*: HH.MM format (preset = 00:00)

* To enter Peak Start and End

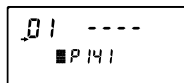

e.g. peak start P141,
energy period 1,
start time blank

Enter the desired time

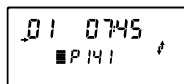

e.g. start time
7.45 am

Scroll (▲ or ▼) or direct
access the desired
energy period.

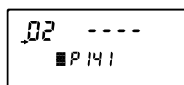

e.g. energy
period 2

P143 (G) PEAK LEAD TIME

Enter the estimated pump running time (in minutes) required to pump the level from the highest Relay A Setpoint (P112) to the lowest Relay B Setpoint (P113) levels.

This value defines the time before the high energy cost period, when the HYDRO+ should start pumping to ensure the level is as far as possible from the Relay A Setpoint (P112) level.

(If the level is already within 5% of Span from the Relay B Setpoint (P113) level, no action is taken).

If multiple pump stations are series linked, ensure the Peak Lead Times entered are sufficient to attain the desired level in all stations before the high energy cost period occurs.

values: 0.000 to 1440

INDEPENDENT PEAK RELAY SETPOINTS A / B

P144 PEAK A SETPOINT

Enter the value (similar to Relay A Setpoint, P112) to be used for the high energy cost period.

This feature allows the level to go beyond the normal Relay A Setpoint before a pump is started.

values: 0.000 to 9999 (preset = 0.000)

P145 PEAK B SETPOINT

Enter the value (similar to Relay B Setpoint, P113) to be used for the high energy cost period.

This feature allows the pump(s) to be stopped before the normal Relay B Setpoint, to reduce pump running time during the high energy cost period.

values: 0.000 to 9999 (preset = 0.000)

The following example illustrates high energy cost usage reduction and/or elimination by utilizing the HYDRO+ Pump Energy Cost Reduction features.

ENERGY SAVING EXAMPLE

(Wet Well, " Pump Down " Application)

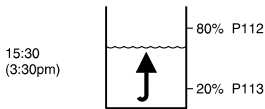

Normal Operation

During low energy cost period Relay A / B Setpoints (P112 / 113) are used to initiate pump starts and pump stops.

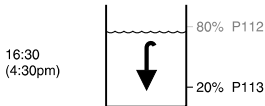

Peak Lead time (P143)

Regardless of the Relay A Setpoint, pump starts are initiated, and level falls to the Relay B Setpoint.



Peak Start Time (P141)

Low level for start of high energy cost period. Now Relay A / B Setpoints are disregarded. Pumping is initiated only if the Peak A / B Setpoints (P144 / P145) are reached. *

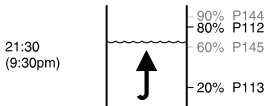

Peak End Time (P142)

With the high energy cost period now over, Peak A / B Setpoints are disregarded. Pumping is initiated as the normal A / B Setpoints are reached.

*** When the Peak A Setpoint is not reached, no energy is used during the " high cost " period. If the Peak A Setpoint is reached, the Wet Well is only pumped down to 60 %, thereby minimizing " high cost " energy usage.**

P146 TIME OF DAY SETPOINT

Use this feature to set the time at which a relay set for time day alarm (P111 = 9) will alarm.

Enter the time in HH.MM (24 hr) format

STORM CONDITIONS (P150 to P152)

These features permit a Storm Condition to be defined, to operate a relay set for the "Storm Control" Relay Function (P111), or modify the operation of a relay set for any "Pump Control", per Storm Action.

Enter Storm A / B Setpoints similar to Relay A / B Setpoints (P112/P113).

A Storm Condition is considered to be in effect if the current level is:

- (a) above the Storm A Setpoint (which is higher than Storm B Setpoint).
- (b) below the Storm A Setpoint (which is lower than Storm B Setpoint).

P150 STORM A SETPOINT

Enter the value (similar to Relay A Setpoint, P112) to define a Storm Condition (in conjunction with Storm B Setpoint).

values: 0.000 to 9999

P151 STORM B SETPOINT

Enter the value (similar to Relay B Setpoint, P113) to define a Storm Condition (in conjunction with Storm A Setpoint).

values: 0.000 to 9999

P152 STORM ACTION

Use this feature to disable a pump for which Storm A / B Setpoints have been entered, to prevent futile running or potential damage due to pumping during flood conditions, (when a Storm Condition exists).

values: 0 = off (pumps are disabled during a Storm Condition).

1 = on (normal operation during a Storm Condition, preset).

P153 STORM MAX DURATION

Use this feature to define the maximum time (in minutes) pumps may be disabled by Storm Action (P152).

values: 0.000 to 9999 (preset = 30 minutes)

FLUSH SYSTEMS (P170 to P173)

Use this feature to define the *flush operation*. When a flush pump (or flush valve in conjunction with a regular pump) is first started, some pump output is diverted back into the vessel to stir up sediment.

P170 FLUSH PUMP

Enter the HYDRO+ Relay Number connected to the pump to be used for the flush operation.

values: 0 to 5 (0 = flush operation disabled, preset)

P171 FLUSH INTERVAL

Enter the number of Pump cycles to occur before the relay set for the "Flush Valve" Relay Function will be operated.

values: 0 to 9999 (0 = flush operation disabled, preset)

P172 FLUSH CYCLES

Enter the number of Pump cycles for which Flush Valve operation (after the Flush Interval and limited by Flush Duration) is desired.

values: 0 to 9999 (0 = flush operation disabled, preset)

P173 FLUSH DURATION

Enter the time to elapse (in seconds) for Flush Valve operation.

values: 0.0 to 9999 (preset = 0.0)

P180 PUMP RATE REFERENCE

This parameter contains a pump rate reference for the assigned pump. The reference value is the change in percent or level ($P050 = 0$), or volume per minute ($P050 \neq 0$) that the pump is rated for. The value is used in the calculation of pump rate efficiency.

values: 0.000 to 9999 (preset = 0)

P181 PUMP RATE TIME

Sets the allotted time, *in seconds*, from when the pump starts, that the actual pump rate is calculated. If another pump is about to start or stop, or this pump is about to stop, the time is cut short and the calculation is done prematurely. The user can ensure that another pump does not start before the pump rate has achieved its operating value by increasing the pump start delay (P132).

values: 0.000 to 9999 (preset = 0)

P182 PUMP RATE

Displays the value of the actual pump rate as calculated over the pump rate time (P181). The value is positive for a change corresponding to the pump function. e.g. For pump down application, a positive value is returned if the level is decreasing.

This parameter can be used to estimate the pump rate reference (P180) by running a pump cycle, then viewing this parameter.

values: -999 to 9999

mA OUTPUT PARAMETERS (P200 to P203, P210 to P215, P219)

If mA output alteration is required, alter the following parameters.

When a mA Output Parameter is accessed, the Point Type symbol changes to "mA".

P200 mA RANGE

Use this feature to alter the mA output range.

If option 1 or 2 is selected, the mA output is directly proportional to the mA Function. (If the Reading is 100% (or equivalent Units) the mA output is 20 mA).

If option 3 or 4 is selected, the mA output is inversely proportional to the mA Function. (If the Reading is 0% (or equivalent Units) the mA output is 20 mA).

value: 0 = off
 1 = 0 to 20 mA
 2 = 4 to 20 mA (preset)
 3 = 20 to 0 mA
 4 = 20 to 4 mA

P201 mA FUNCTION

Use this feature to alter the mA output/measurement relationship.

This value is automatically altered when Operation (P001) is altered.

| mA Function | when Operation is... |
|-------------|---------------------------------------|
| level | "level", "differential", or "average" |
| space | "space" |
| distance | "distance" |
| volume | "level" or "space" (see conditions*) |
| flow | "OCM" |

* altered when a Tank Shape (P050) is programmed if the mA Allocation has not been altered.

values: 0 = off
 1 = level
 2 = space
 3 = distance
 4 = volume
 5 = flow
 6 = head
 7 = volume rate

P202 mA ALLOCATION

Use this feature to alter the mA output/Point Number allocation. As preset, the mA output pertains to Point Number 1.

This value may only be altered if Operation is set for *DPD* (Differential Level, P001 = 4) or *DPA* (Average Level, P001 = 5).

To have the mA output proportional to the differential or average level, allocate the mA output to Point Number 3.

Enter the Point Number the mA output is to be based upon.

values: 1 = Point 1

2 = Point 2

3 = Point 3

P203 (V) mA VALUE / TRANSDUCER

View the current mA output value for the Point Number displayed.

The value displayed does not include any adjustment made using the 4 or 20 mA Trim features (P214 / P215).

This is the value displayed as an Auxiliary Reading when  is pressed in the RUN mode.

values: 0.000 to 22.00

INDEPENDENT mA SETPOINTS (P210 and P211)

Use these features to reference the minimum and/or maximum mA output to any point in the measurement range.

If mA Function (P201) is set for "level", "space", or "distance", enter the material level in Units (P004) or percent of Span (P007) as referenced to Empty (P006).

If mA Function is set for "volume", enter the volume in Max Volume (P051) units or as a percent of Max Volume.

If mA Function is set for "flow", enter the flowrate in OCM Max Flow (P604) units or as a percent of OCM Max Flow.

If mA function is set for "head", enter the head in level units (P004) or percent of Max Head (P603).

If mA function is set for "volume rate", enter the volume rate in volume / min.

Ensure the % symbol is displayed before attempting to enter a % value, (see **PROGRAMMING** Keypad).

These features are preset dependent upon mA Range (P200) and mA Function (P201).

P210 0/4 mA SETPOINT

Enter the value (in applicable units or %) to correspond to 0 or 4 mA.

values: -999 to 9999

P211 20 mA SETPOINT

Enter the value (in applicable units or %) to correspond to 20 mA.

values: -999 to 9999

INDEPENDENT mA LIMITS (P212 and P213)

Use these features to adjust the minimum and/or maximum mA output value limits.

Typically, the value entered is to suit the minimum and/or maximum input limit requirements of the device connected to the HYDRO+ mA output terminals.

P212 mA MIN LIMIT

Enter the minimum mA output value (in mA) to be produced.

This feature is preset to 0.0 or 3.8 mA, (per mA Function, P200).

values: 0.000 to 22.00

P213 mA MAX LIMIT

Enter the maximum mA output value (in mA) to be produced.

This feature is preset to 20.2 mA.

values: 0.000 to 22.00

INDEPENDENT mA TRIM

Use these features if the device connected to the HYDRO+ mA output terminals is out of calibration, yet device recalibration is impractical.

Use of these features does not affect the mA Value / Transducer (P203) value displayed.

P214 4 mA TRIM

Adjust this value (in mA) as required to make the device connected indicate 4.000 mA when this parameter is accessed.

values: -1.00 to 1.000

P215 20 mA TRIM

Adjust this value (in mA) as required to make the device connected indicate 20.00 mA when this parameter is accessed.

values: -1.00 to 1.000





INDEPENDENT mA FAILSAFE

P219 mA FAILSAFE

Use this feature for mA output failsafe operation, independent from the Failsafe Material Level (P071).

| OPTION | DESCRIPTION |
|--------|--|
| "OFF" | (preset) mA output responds to Failsafe Material Level (P071). |
| "HOLD" | the "last known" value is held until normal operation resumes. |
| "LO" | produce the "Empty" mA output immediately. |
| "HI" | produce the "Span" mA output immediately. |

To select an independent mA Failsafe option:

-  , to display the Auxiliary Function symbol,
-  or  , to scroll access the failsafe options.
-  , with the desired option displayed.

Alternatively, to produce an immediate mA output at a specific value, enter the value required.

values: 0.000 to 22.00

mA INPUT PARAMETERS (P250,P251,P252)

If HYDRO+ features are required based upon measurements obtained from another level monitor, alter the following parameters as required.

This feature enables virtually all HYDRO+ (excluding Transducer specific) features to be used, based upon the measurements of another level monitor (or any device providing a 0 to 20 mA or 4 to 20 mA output proportional to level).

To use this feature, do not connect an ultrasonic transducer to the HYDRO+ transducer terminals). Connect the mA output of the device to the HYDRO+ mA input terminals, and set TRANSDUCER to "Auxiliary" (P004 = 250).

Do not connect the auxiliary device to the HYDRO+ transducer terminals.

P250 (G) mA INPUT RANGE

Enter the mA output range of the auxiliary level monitor connected.

value: 1 = 0 to 20 mA

2 = 4 to 20 mA (preset)

INDEPENDENT mA INPUT SETPOINTS (P251 and P252)

Use these features to define the levels associated with the mA Input Range. Enter the levels in Units (P004) or % of Span (P007), as referenced to Empty (P006).

Ensure the % symbol is displayed before attempting to enter a % value, (see **PROGRAMMING** Keypad).

P251 (G) 0/4 mA INPUT SETPOINT

Enter the level (in Units or %) to correspond to 0 or 4 mA.

As preset, 0 or 4 mA (dependent upon mA Input Range, P250) "IN" represents a level at 0 % of Span (or equivalent units).

values: -999 to 9999

P252 (G) 20 mA INPUT SETPOINT

Enter the level (in Units or %) to correspond to 20 mA.

As preset, 20 mA "IN" represents a level at 100% of Span (or equivalent units).

values: -999 to 9999

DATA LOGGING PARAMETERS

Use these features to view time and date stamped data, pertaining to operation.

To view Data Logging Parameter time stamps,   .

To view date stamps,   .

RECORD TEMPERATURES (P300 to P303)

Use these features to identify the occurrence of record high and / or low temperatures as recorded in °C.

When a parameter relating to a TS-3 Temperature Sensor is accessed, the Point Type display changes to the TS-3 symbol.

P300 (V) TEMPERATURE, TRANSDUCER MAX

View the highest temperature encountered, as measured by the Ultrasonic / Temperature Transducer (if applicable).

values: - 50 to 150 (preset = - 50)

P301 (V) TEMPERATURE, TRANSDUCER MIN

View the lowest temperature encountered, as measured by the Ultrasonic / Temperature Transducer (if applicable).

values: - 50 to 150 (preset = 150)

P302 (V) TEMPERATURE, SENSOR MAX

View the highest temperature encountered, as measured by the TS-3 Temperature Sensor (if applicable).

values: - 50 to 150 (preset = - 50)

P303 (V) TEMPERATURE, SENSOR MIN

View the lowest temperature encountered, as measured by the TS-3 Temperature Sensor (if applicable).

values: - 50 to 150 (preset = 150)

RECORD READINGS (P304 and P305)

Use these features to identify the occurrence of the record high and low Readings.

P304 (V) READING MAX

View the highest Reading calculated (in normal Reading units or %).

values: -999 to 9999

P305 (V) READING MIN

View the lowest Reading calculated (in normal Reading units or %).

values: -999 to 9999

PUMP RECORDS (P310 to P312)

Use these features to identify pump usage.

When any of these features are accessed, the Point Type display changes to the Relay Symbol and the Relay Number (corresponding to HYDRO+ terminals) is displayed in the Point Number field.

These features are enabled if the associated Relay Function (P111) is set for any "pump control" feature. The value displayed pertains to the pump connected to the associated HYDRO+ terminals.

Enter "0" (if desired) when these parameters are accessed, to reset these features (perhaps when a new replacement pump is installed). Alternatively, enter any other (applicable) value (perhaps when a used replacement pump is installed).

During operation, these values are dynamic (continuously changing). Once per hour, the dynamic value is stored in non-volatile EEPROM memory. Therefore, in the event of a power interruption, upon power resumption, the value will be correct to within at least 60 minutes prior to the interruption.

If desired, connect a backup dc power source to the HYDRO+ to ensure the Pump Records are not affected by an ac power interruption.

(See **INSTALLATION** Interconnection / Power).

P310 PUMP HOURS

View the accumulated "ON" time for the displayed Relay Number.

This value is displayed with a floating decimal point. (i.e. the more figures displayed before the decimal, the fewer displayed after).

values: 0.000 to 9999

P311 PUMP STARTS

View the accumulated number of times the displayed Relay Number has been "ON".

values: 0 to 9999

P312 PUMP RUN ONS

View the accumulated number of times the displayed Relay Number has been held "ON" via Run On Interval (P130).

values: 0 to 9999

FLOW RECORDS (P320 and P321)

These features are enabled if Operation is set for "OCM" (P001 = 6). Use these features to identify the occurrence of the record high and low flowrates as displayed in OCM MAX FLOW (P604) units, or as a percent of OCM MAX FLOW.

P320 (V) FLOW MAX

View the highest flowrate calculated (in units or %).

values: -999 to 9999

P321 (V) FLOW MIN

View the lowest flowrate calculated (in units or %).

values: -999 to 9999

LCD TOTALIZER (P322 and P323)

Use these features to view, reset, or preset the 8 digit display totalizer.

These features may be enabled if Operation is set for "OCM" or "Pumped Volume" (P001 = 6 or 7).

The 8 digit totalizer display is divided into 2 groups of 4 digits in the program mode. For this reason, the 4 least significant totalizer digits are stored in one parameter and the 4 most significant digits are stored in another.

e.g. P323 & P322 = 8 Digit Value
 0017 6.294 = 176.294

Totalizer units are dependent upon programming.

Enter "0" (if desired) when these parameters are accessed, to reset the totalizer to zero. Alternatively, enter any other (applicable) value, to preset the totalizer to the value desired.

During operation, these values are dynamic (continuously changing). Once per hour, the dynamic value is stored in non-volatile EEPROM memory. Therefore, in the event of a power interruption, upon power resumption, the value will be correct to within at least 60 minutes prior to the interruption.

If desired, connect a backup dc power source to the HYDRO+ to ensure the totalizer value is not affected by an ac power interruption.

(See **INSTALLATION** Interconnection / Power).

P322 LCD TOTAL LOW

View and / or alter the 4 least significant digits of the totalizer value.

values: 0.000 to 9999

P323 LCD TOTAL HIGH

View and / or alter the 4 most significant digits of the totalizer value.

values: 0000 to 9999

PROFILE RECORDS (P330 to P337)

The following parameters are for authorized Milltronics service personnel or Instrumentation Technicians familiar with Milltronics echo processing techniques.

Use these features to record and save a total of up to 10 Echo profiles, initiated manually (P330), or automatically (P331 et al). Each record is time and date stamped as to when the profile was saved. See Scope displays (P810) for echo profile viewing hardware / software requirements.

If 10 Echo Profiles are already saved, addresses 1 through 10 are filled, the oldest automatically initiated record is overwritten. Manually initiated records are not automatically overwritten. All records are automatically deleted in the event of a power interruption.

When a record is displayed, results are based on current programming (which may have been altered since the record was saved). This permits the effect on the echo profile to be observed when changing an echo parameter.

P330 PROFILE RECORD

In addition to serving as a library for profile records, this parameter provides two functions:

- » manually records and saves echo profiles
- » displays an echo profile, recorded manually or automatically, e.g. via an oscilloscope.

To select a record address:

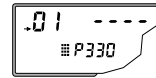

e.g. initial parameter display



until address index is enabled.



selects the desired address, 1 to 10, and displays the associated parameter value:

' - - - ' = no record
' x#' = record
where: x = A, automatically initiated
 = U, manually initiated
 # = transducer number

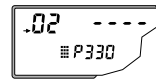

e.g. address 2 selected,
no record saved

To manually record a profile:



the transducer* fires and an echo profile is recorded into the internal scope buffer for display.

To save a manual record:



copies the echo profile record in the scope buffer and saves it in the selected address in the record library. The parameter value field displays the new record ordinates.

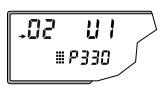

e.g. manually initiated record from transducer 1 saved in address 2

To display a record



displays the time when the profile was saved



e.g. record 3 selected



displays the date when the profile was saved



copies the echo profile record in the selected address to the scope buffer, for display.

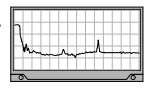

e.g. oscilloscope displays record in address 3

To delete a record:



deletes the echo profile record in the selected address. Parameter value returns to '----'.

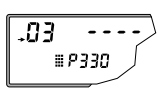

e.g. record deleted, address 3 clear

* For differential or average operation (P001 = 4 or 5), access scope Displays (P810) parameter to select the transducer number.

P331 (G) AUTO RECORD ENABLE

Use this feature (if desired) to enable / disable the Auto Profile Record function.

values: 0 = off
1 = on

P332 (G) AUTO RECORD TRANSDUCER

Use this feature (if desired) to specify the Transducer Point Number for which Auto Profile Records are saved.

This feature is preset to Point Number 1. (Alteration is only required if "differential" or "average" Operation (P001 = 4 or 5) is selected).

values: 0 = any Transducer
1 = Transducer 1 (preset)
2 = Transducer 2

P333 (G) AUTO RECORD INTERVAL

Enter the time (in minutes) to elapse after an Auto Profile Record is saved before another Auto Profile Record can be saved (subject to all other restrictions).

values: 0.000 to 9999 (preset to 120 minutes)

AUTO RECORD A / B Setpoints

Use Auto Record A Setpoint (P334) and Auto Record B Setpoint (P335) to define the boundaries within which the level must be, for the resultant Echo Profile to be considered for an Auto Profile Record.

If "----" is displayed for either P334 or P335, Auto Profile Records are saved regardless of current level (subject to all other restrictions).

Enter the level value in Units (P004) or percent of Span (P007) as referenced to Empty (P006). (Ensure the % Symbol is displayed before attempting to enter a value in percent, see **PROGRAMMING** keypad).

P334 (G) AUTO RECORD A SETPOINT

Enter the critical level which, in conjunction with Auto Record B Setpoint, defines the boundaries for Auto Profile Records to be saved.

values: -999 to 9999

P335 (G) AUTO RECORD B SETPOINT

Enter the critical level which, in conjunction with Auto Record A Setpoint, defines the boundaries for Auto Profile Records to be saved.

values: -999 to 9999

P336 (G) AUTO RECORD FILLING / EMPTYING

Use this feature to restrict Auto Profile Records from being saved unless the level is rising, falling or either.

If the level changes at a rate in excess of the corresponding Filling / Emptying Indicator (P702 / P703) values, the Echo Profile is saved subject to this and other Auto Profile Record restrictions.

values: 0 = Auto Profile Record on filling or emptying (preset)
 1 = Auto Profile Record on filling only.
 2 = Auto Profile Record on emptying only.

P337 (G) AUTO RECORD LOE TIME

Use this feature to restrict Auto Profile Records from being saved unless an extended loss of echo (LOE) condition occurs.

If the LOE condition exceeds the period entered (in seconds) the Echo Profile is saved, subject to this and other restrictions.

When set for "0" (preset), LOE is not required for an Auto Profile Record to be saved.

values: 0.0 to 9999

INSTALLATION RECORDS (P340 to P342)

Use these features to view data relating to this specific HYDRO+ installation.

P340 (V) DATE OF MANUFACTURE

View the date of manufacture of this HYDRO+.

values: YY:MM:DD format

P341 (V) RUN TIME

View the accumulated number of days this HYDRO+ has been operating, since the Date of Manufacture (P340).

This value is saved in EEPROM and updated once each day. Therefore, if the HYDRO+ is powered down at least once every 24 hour period, this value will always be less than 1.

values: 0.000 to 9999

P342 (V) START UPS

View the accumulated number of times power has been applied to the HYDRO+ (following a power interruption), since the Date Of Manufacture.

values: 1 to 9999

OCM PARAMETERS (P600 - P607, P610, P611, P620, P621)

If The HYDRO+ is used to monitor open channel flow, alter the following parameters as required.

The HYDRO+ calculates "head" as referenced to Empty (P006) or OCM Zero Offset (P605), when Operation is set for "OCM" (P001 = 6). Flowrate, based on head (at the "point of measure" specified by the PMD fabricator) is also calculated.

P600 (G) PRIMARY MEASURING DEVICE

Enter the type of primary measuring device (PMD) used.

If Operation is not set for "OCM" (P001 = 6), this value is preset to "0". If Operation is set for "OCM", this value is preset to "1".

The HYDRO+ is preprogrammed with the flow constant for common PMD flow calculations. If the PMD used is not specifically identified, select the appropriate Universal Flow Calculation.

Associated parameters (as indicated below), Max Head (P603), Max Flow (P604), and Min Head (P605) may be scroll accessed.

- values:
- 0 = off (no calculation)
 - 1 = exponential (see P601)
 - 2 = Palmer-Bowlus Flume (see P602)
 - 3 = H-Flume (see P602)
 - 4 = Universal Linear Flow Calculation (see P610, P611)
 - 5 = Universal Curved Flow Calculation (see P610, P611)
 - 6 = BS - 3680 / ISO 4359 Rectangular Flume
 - 7 = BS - 3680 / ISO 1438/1 Thin Plate V-notch Weir

P601 (G) FLOW EXPONENT

Exponent PMD (P600 = 1) where $Q = KH^X$

Enter the exponent specified by the PMD manufacturer (preset 1.55)

WEIRS

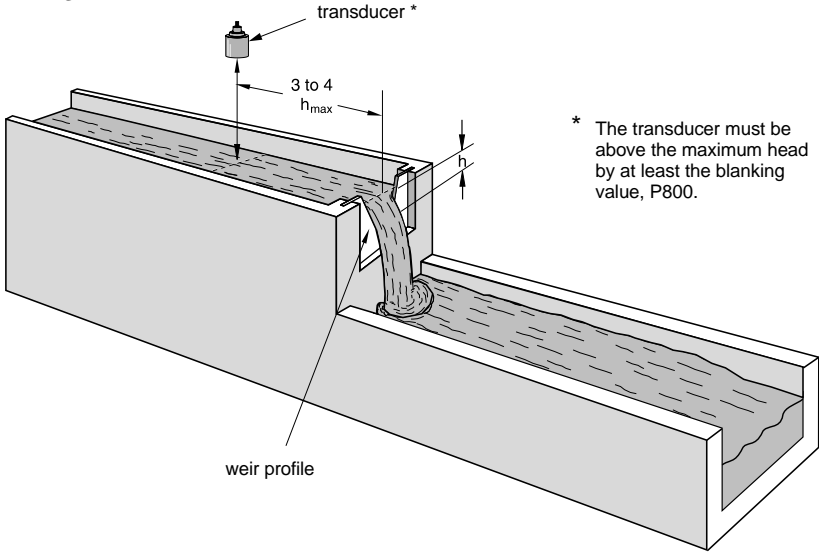

Applicable Weir Profiles

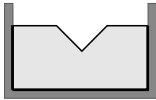

V -notch or
triangular

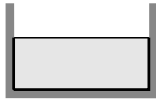

suppressed
rectangular

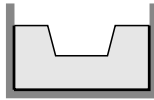

Cipolletti or
trapezoidal

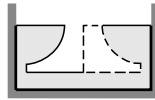

Sutro or
proportional

Non-Applicable Weir Profiles

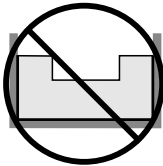

contracted
rectangular

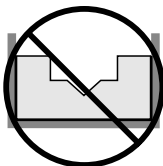

compound

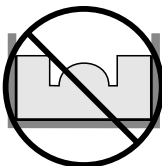

Poebing

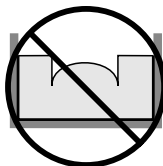

approximate
exponential

**Flows through these weirs may be measured using
the universal flow calculation P600 = 4 or 5.**

P601 for P600 = 1 (cont'd)

FLUMES

Parshall Flume

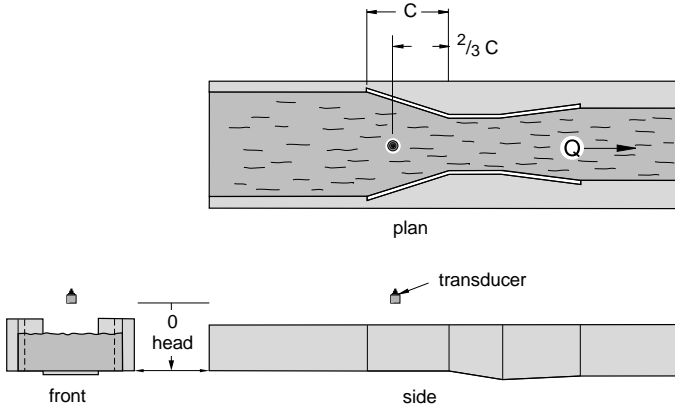

- » sized by throat width
- » set on solid foundation
- » general free flow equation is $Q = KH^x$ where:
 - Q = flow rate
 - K = constant
 - H = head
 - x = exponent

» For rated flows under free flow conditions, the head is measured at $\frac{2}{3}$ the length of the converging section from the beginning of the throat section.

Khafagi Venturi

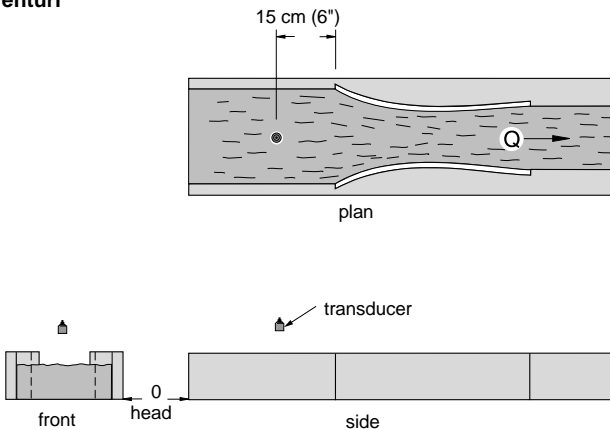

» for rated flows under free flow conditions, the head is measured 15 cm (6") upstream from the beginning of the converging section.

P601 for P600 = 1 (cont'd)

FLUMES (cont'd)

Leopold Lagco (as manufactured by Leopold Co., Inc.)

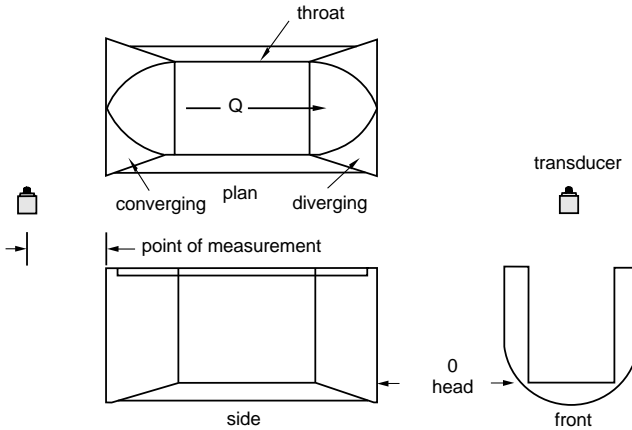

- » designed to be installed directly into pipelines and manholes
- » Leopold Lagco may be classed as a rectangle Palmer-Bowlus flume
- » sized by pipe (sewer) diameter
- » for rated flows under free flow conditions, the head is measured at a point upstream referenced to the beginning of the converging section. Refer to the following table :

| Flume Size (pipe dia. in inches) | Point of Measurement | |
|-------------------------------------|----------------------|--------|
| | cm | inches |
| 4 - 12 | 2.5 | 1 |
| 15 | 3.2 | 1 1/4 |
| 18 | 4.4 | 1 3/4 |
| 21 | 5.1 | 2 |
| 24 | 6.4 | 2 1/2 |
| 30 | 7.6 | 3 |
| 42 | 8.9 | 3 1/2 |
| 48 | 10.2 | 4 |
| 54 | 11.4 | 4 1/2 |
| 60 | 12.7 | 5 |
| 66 | 14.0 | 5 1/2 |
| 72 | 15.2 | 6 |

- » general free flow equation is $Q = KH^x$, where:
 - Q = flow
 - K = constant
 - H = head
 - x = exponent

P601 for P600 = 1 (cont'd)

FLUMES (cont'd)

Cut Throat Flume

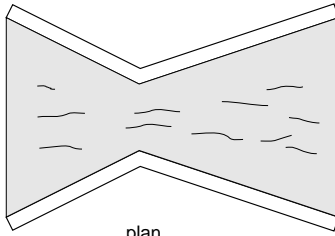

- » similar to Parshall flume except that the floor is flat bottomed and throat has no virtual length.
- » refer to manufacturer's specifications for flow equation and point of head measurement.

P602 OCM DIMENSION

This parameter lists the required dimensions for the OCM device selected (P600).

P602 not applicable for P600 = 0, 1, 4 and 5.

To enter an OCM dimension . . .

P600 = 6

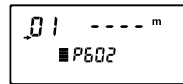

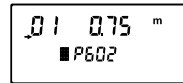

e.g. index no. 1,
approach width B,
blank

Enter the approach width



e.g. 0.75 m

Scroll ( or ) or direct access the desired dimension.

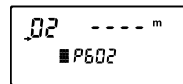

e.g. index no. 2,
throat width b,
blank

(P602 cont'd)

values (P600 = 2):

| index | value |
|-------|---------------|
| 1 | flume width D |

Palmer Bowlus Flume

(typically those manufactured by Warminster Fiberglass or Plasti-Fab)

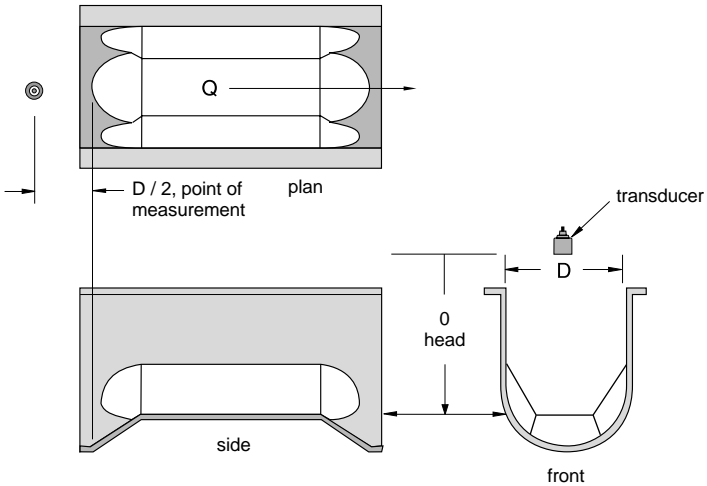

- » sized by pipe diameter, D. Enter value (in units of P005) into P602.
- » flume relief is trapezoidal
- » designed to install directly into pipelines and manholes
- » head is referenced to bottom of the throat not to bottom of pipes.
- » for rated flows under free flow conditions, the head is measured at a distance of $D / 2$ upstream from the beginning of the converging section.

(P602 cont'd)

values (P600 = 3):

| | |
|-------|----------|
| index | value |
| 1 | height D |

H Flume

(as developed by the U.S. Department of Agriculture, Soil Conservation service)

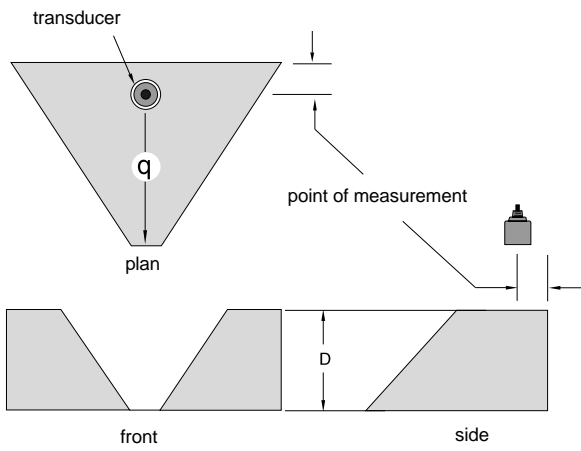

- » sized by max depth of flume, D. Enter value (in units of P005) into P602.
- » approach is preferably rectangular, matching width and depth for distance 3 to 5 times the depth of the flume.
- » may be installed in channels under partial submergence (ratio of downstream level to head).
- Typically: » 1% error @ 30% submergence
- » 3% error @ 50% submergence
- » for rated flows under free flow conditions, the head is measured at a point downstream for the flume entrance.

| Flume Size (D ft) | Point of Measurement | |
|------------------------|----------------------|--------|
| | cm | inches |
| 0.5 | 5 | 1 3/4 |
| 0.75 | 7 | 2 3/4 |
| 1.0 | 9 | 3 3/4 |
| 1.5 | 14 | 5 1/2 |
| 2.0 | 18 | 7 1/4 |
| 2.5 | 23 | 9 |
| 3.0 | 28 | 10 3/4 |
| 4.5 | 41 | 16 1/4 |

» H flumes come with a flat or sloping floor. The same flow table can be used as error is less than 1%.

(P602 cont'd)

values (P600 = 6):

| index | value |
|-------|-----------------------------|
| 1 | approach width B |
| 2 | throat width b |
| 3 | hump height p |
| 4 | throat length L |
| 5 | velocity coefficient C_v |
| 6 | discharge coefficient C_d |
| 7 | A |

BS-3680 / ISO 4359 Rectangular Flume

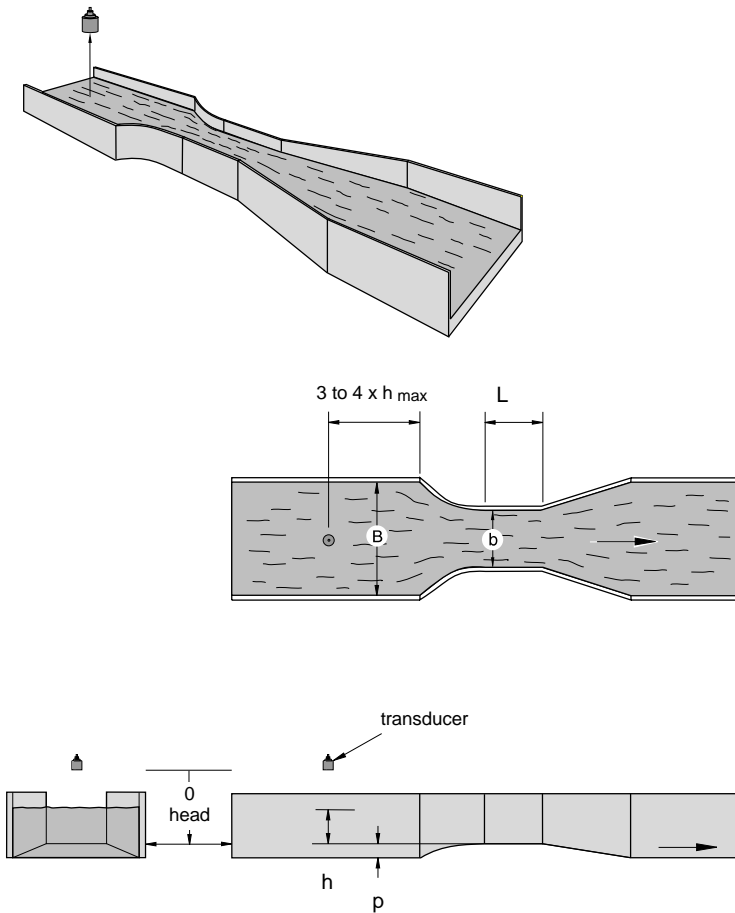

(P602 cont'd)

values (P600 = 7):

| index | value |
|-------|-----------------------------|
| 1 | notch angle α |
| 2 | discharge coefficient C_e |

BS-3680 Thin Plate V Notch Weir

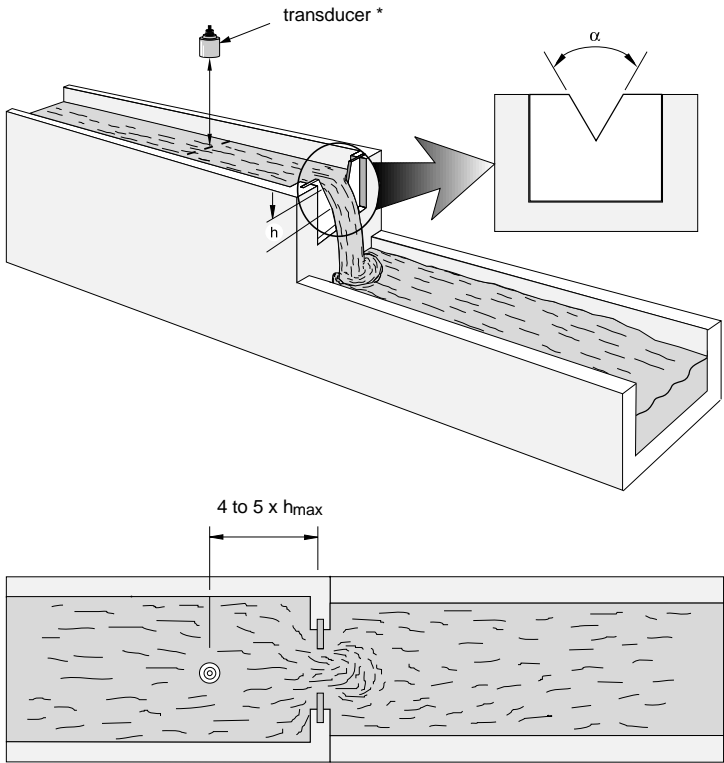

* The transducer must be above the maximum head by at least the blanking value, P-800.

P603 (G) MAX HEAD

Enter the head value associated with Max Flow, in Units (P004).

values: -999 to 9999 (preset = Span, P007 value)

P604 (G) MAX FLOW

Enter the flowrate associated with Max Head, in any flowrate units (flowrate units = volume units / time units) using the Time Units (P606).

e.g. If flowrate is to be displayed in 1000's of L³ / day, and the maximum flowrate is 376,500 L³ / day, enter 376.5.

values: -999 to 9999 (preset = 1000)

P605 (G) ZERO HEAD

Enter the distance above Empty (P006) in Units (P005) representing zero head (and flow).

This feature is used for weirs and flumes (e.g. Palmer Bowlus) whose zero reference is at a higher elevation than the channel bottom at the point of measure (transducer location).

values: -999 to 9999 (preset = 0.000)

P606 (G) TIME UNITS

Enter the Time Units to be used in conjunction with volume units to derive the desired flowrate units as entered for Max Flow (P604).

This parameter is used only for ratiometric calculations. For devices that support absolute calculations (P600 = 6 & 7), the time interval is defined by OCM units (P608).

values: 1 = seconds
2 = minutes
3 = hours
4 = days (preset)

(e.g. litres / second, enter 1)

P607 (G) FLOWRATE DECIMAL

Enter the maximum number of decimal places to be displayed.

In the RUN mode, the number of decimal places displayed is automatically adjusted (if necessary) to prevent the number of Flowrate digits from exceeding display capabilities.

(The max. number of "head" decimal places is controlled by Decimal Position [P060]).

values: 0 = no digits after the decimal point
1 = 1 digit after the decimal point
2 = 2 digits after the decimal point
3 = 3 digits after the decimal point

P608 OCM UNITS

This parameter is enabled only if the primary measuring device (P600) supports absolute calculations.

values: *ratiometric*
0 = ratiometric calculation (units defined by P604)

absolute
1 = litres / second
2 = cubic metres / hour
3 = cubic metres / day
4 = cubic feet / second
5 = gallons / minute – imperial
6 = million gallons / day – imperial
7 = gallons / minute – U.S.
8 = million gallons / day – U.S.

Head and Flowrate Breakpoint

When the primary measuring device (P600) does not fit one of the standard characterizations, it may be programmed for one of two breakpoint characterizations:

- » P600 = 4 : linear
- » P600 = 5 : curved

Select the characterization which most closely fits the flow characteristics of the primary measuring element.

Typical PMD for Breakpoint Characterization

Trapezoidal Flume

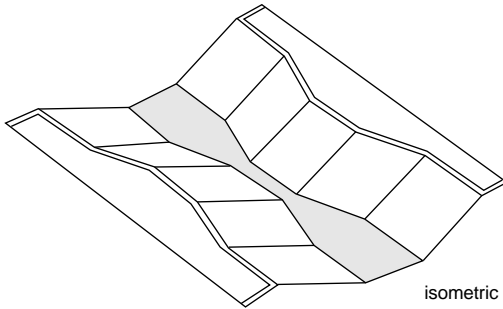

- » similar to Parshall Flume except that the floor is flat bottomed and the walls are sloped.

Dual Range (nested) Parshall Flume

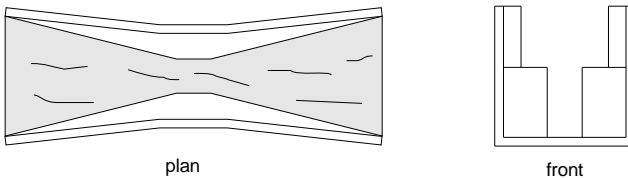

- » two flumes, a larger on top of the smaller, in order to handle a larger range of flows.

Weir Profiles

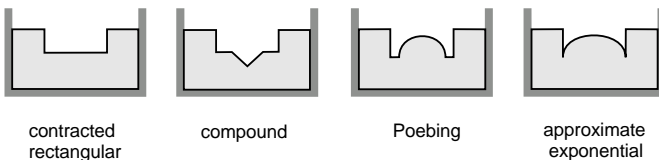

Typical Flow Characterization

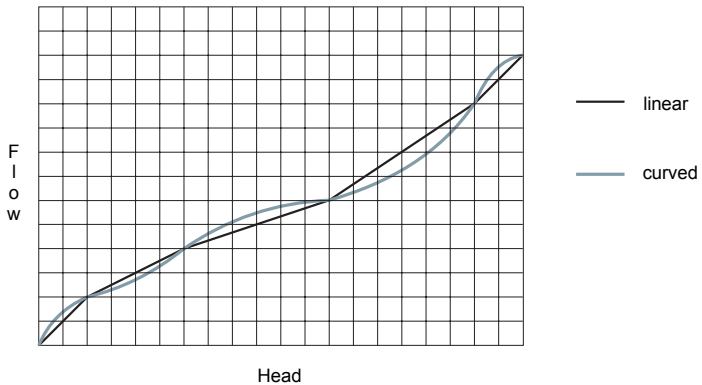

Characterization is achieved by entering the head (P610) and corresponding flow (P611), either from empirical measurement or from the manufacturer's specification. The more breakpoints that are defined, the more accurate will be the flow measurement. Breakpoints should be concentrated in areas exhibiting the higher degrees of non linear flow. A maximum of thirty-two breakpoints can be defined.

P610 (G) HEAD BREAKPOINTS

Enter the head breakpoints * for which flowrate is known.

values: 0.000 to 9999

P611 (G) BREAKPOINT FLOWRATES

Enter the flowrate * corresponding to each Head Breakpoint entered.

values: 0.000 to 9999

* To enter a Head or Flowrate Breakpoint . . .

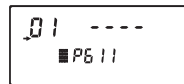

e.g. breakpoint flowrate, breakpoint 1, value blank

Enter the desired value



e.g. 7.5

Scroll (▲ or ▼) or direct access the desired breakpoint.

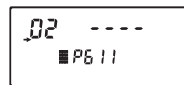

e.g. breakpoint 2

Refer to **TECHNICAL REFERENCE** Flow Calculation for breakpoint value selection assistance.

P620 (G) LOW FLOW CUTOFF

Use this feature to enter the minimum head in units (P005) or as a percent of span.

Ensure the % symbol is displayed before attempting to enter a value in percent, (see **PROGRAMMING** Keypad).

This feature eliminates totalizer activity for flows at or below the cutoff value.

values: 0.000 to 9999 (preset = 5.000 %, or equivalent units)

P621 (G) AUTO ZERO HEAD

Use this feature to calibrate Zero Head (P605), especially if the reported head is consistently high or low by a fixed amount).

Before using this feature, verify the following parameters are correct:

Empty (P006), Temperature (P664), Offset Reading (P062=0), Zero Head Offset (P605)

With "head" steady ...

1.  to display the calculated head,
2. Repeat step 1 at least 5 times to verify repeatability,
3. Measure the "actual" head (e.g. with a tape measure or solid rule)
4. Enter the "actual" head value.

The deviation between the entered Empty (P006) value and the calibrated "Empty" value, is stored in Offset Correction (P650).

values: -999 to 9999

TOTALIZER PARAMETERS (P622,P630,P633,P640-P642,P645)

If the *8 digit totalizer display* (LCD TOTAL), or a remote totalizer contact closure is desired, alter the following parameters as required.

P622 (G) INFLOW / DISCHARGE ADJUST

This parameter selects the method used to calculate the volume pumped, for "pumped total" Operation (P001 = 7).

values: 1 = inflow * / pump cycle

When the pump is off, the HydroRanger plus estimates the volume of inflow by recording the rate at which the liquid level changes. When the pump is operating, the estimated inflow volume is added to the pumped volume total, as in batch processing. When the pump stops, the pumped volume of the previous pump cycle is added to the total volume pumped in the totalizer.

2 = inflow * ignored

Inflow is assumed to be 0 while pumps are running.

3 = inflow * / rate (preset)

Volume pumped is adjusted for inflow. Inflow rate is estimated by assuming that the rate calculated (P708) just prior to the start of the pump cycle remained constant during the pump cycle. Inflow rate is averaged using rate filter (P704), rate update time (P705) and rate update distance (P706) to control how the average rate is calculated.

* or discharge

P623 PUMP TOTAL METHOD

This parameter determines the method used for updating the pumped volume totalizer.

values: 1 = Volume pumped is calculated from the volume readings at the start and end of the pump cycle. The result is compensated for estimated inflow which is added to the total volume change while pumps are running. Inflow rate is estimated as selected by the inflow / discharge adjust (P622).

2 = Volume pumped is calculated from the pump rate (P182) for each pump, and the running time of each pump. Pump rate is recalculated on each pump cycle, based on the rate of change of level or volume before and after each pump starts. Accuracy of the totalizer when using this selection is entirely dependent on the accuracy of the rate calculation, so the user must ensure that appropriate settings are entered for pump rate time (P181), start delay (P132). (preset)

P630 (G) LCD TOTAL FACTOR

Use this feature if the LCD Total increments/decrements by too large (or small) an amount.

Enter the factor (powers of 10 only) by which actual volume is divided, prior to LCD Total display.

e.g. for an LCD Total display in 1000's of volume units, enter 3.

| | |
|-------------------|----------------|
| values: -3 = .001 | 3 = 1000 |
| -2 = .01 | 4 = 10,000 |
| -1 = .1 | 5 = 100,000 |
| 0 = 1 (preset) | 6 = 1,000,000 |
| 1 = 10 | 7 = 10,000,000 |
| 2 = 100 | |

If this parameter is changed, reset the totalizers (P322 and P323).

P633 (G) LCD TOTAL DECIMAL

Enter the maximum number of decimal places to be displayed.

In the RUN mode, the number of decimal places displayed is not automatically adjusted. When the LCD Total value is so large as to exceed display capabilities, the total "rolls over" to "0" and continues incrementing.

| |
|---|
| values: 0 = no digits after the decimal point |
| 1 = 1 digit after the decimal point |
| 2 = 2 digits after the decimal point |
| 3 = 3 digits after the decimal point |

If this parameter is changed, reset the totalizers (P322 and P323).

P640 (G) REMOTE TOTAL FACTOR

Use this feature if the remote totalizer (device connected to the relay set for "totalizer operation" Relay Function, P111 = 40), updates too slowly or rapidly.

Enter the factor (powers of 10 only) by which actual volume is divided, prior to Remote Totalizer count increment.

e.g. for a Remote Totalizer update by 1000's of volume units, enter 3.

| | |
|-------------------|----------------|
| values: -3 = .001 | 3 = 1000 |
| -2 = .01 | 4 = 10,000 |
| -1 = .1 | 5 = 100,000 |
| 0 = 1 (preset) | 6 = 1,000,000 |
| 1 = 10 | 7 = 10,000,000 |
| 2 = 100 | |

If this parameter is changed, reset the totalizers (P322 and P323).

P641 (G) FLOW SAMPLER MANTISSA

Use this feature in conjunction with *Flow Sampler Exponent* (P642) to establish the number of flow units required to increment the *Flow Sampler* (device connected to the HYDRO+ relay set for the "flow sampler operation" Relay Function, P111 = 41).

Enter the mantissa (X) for the exponent (Y) in the formula...

Flow Sampler Increment = $X \times 10^Y$ Flow units.

e.g. (To count once every 5000 (5×10^3) flow units, set P641 to 5 and P642 to 3)

values: 0.001 to 9999 (preset = 1.000)

P642 (G) FLOW SAMPLER EXPONENT

Use this feature in conjunction with *Flow Sampler Mantissa* (P641) to establish the number of flow units required to increment the *Flow Sampler* (device connected to the HYDRO+ relay set for the "flow sampler operation" Relay Function, P111 = 41).

Enter the exponent (Y) for the mantissa (X) in the formula...

Flow Sampler Increment = $X \times 10^Y$ Flow units.

values: -3 to +7 (whole numbers only, preset = 0)

P645 (G) RELAY ON TIME

Use this feature (if desired) to adjust the minimum contact closure duration of a relay set for a "totalizer, flow sampler, or time control" Relay Function (P111 = 40, 41, or 60).

Enter the minimum contact closure duration (in seconds) required by the device connected. This value is automatically limited by the Relay C / D Setpoint (P114 / P115) values.

values: 0.0 to 9999 (preset = 0.2)

RANGE CALIBRATION PARAMETERS (P650 to P654)

P650 OFFSET CALIBRATION

Use this feature to calibrate Empty (P006), especially if the reported level is consistently high or low by a fixed amount, (e.g. 2 cm).

Before using this feature, verify the following parameters are correct:

Empty (P006), Temperature (P664), Offset Reading (P062),
Zero Head Offset (P605), if used.

With the level steady ...

1.  to display the calculated space, level, or distance.
2. Repeat step 1 at least 5 times to verify repeatability.
3. Measure the actual space, level, or distance (e.g. with a tape measure).
4. Enter the actual value.

The deviation between the entered Empty (P006) value and the calibrated "Empty" value, is stored in Offset Correction (P650).

values: -999 to 9999

P651 SOUND VELOCITY CALIBRATION

Use this feature if:

- a) The acoustic beam atmosphere is other than "air".
- b) The acoustic beam atmosphere temperature is unknown.
- c) The Reading accuracy is acceptable at higher material levels only.

With the level steady at some low value...

1. Allow sufficient time for the vapour concentration to stabilize.
2.  to display the calculated space, level, or distance.
3. Repeat step 2 at least 5 times to verify repeatability.
4. Measure the actual space, level, or distance (e.g. with a tape measure).
5. Enter the actual value.

(Velocity parameters P653 and P654 are adjusted accordingly).

Repeat this procedure if the atmosphere type, concentration, or temperature varies from that present when the last sound velocity calibration was performed.

values: -999 to 9999

P652 OFFSET CORRECTION

This value is altered when an Offset Calibration is performed.

Alternatively, if the amount of Offset Correction required is known, enter the amount to be added to the Reading before display.

values: -999 to 9999

P653 VELOCITY

This value is adjusted, based on the "Sound Velocity at 20 °C (P654) vs. Temperature (P664) characteristics of air".

Alternatively, enter the current sound velocity (if known), or perform a Sound Velocity Calibration (P651).

The units used are m/s if P005 = 1, 2, or 3 (ft/s if P005 = 4 or 5).

values: 50.01 to 2001 m/s (164.1 to 6563 ft/s)

P654 VELOCITY AT 20 °C

This value is used to automatically calculate Sound Velocity (P653).

After performing a Sound Velocity Calibration, check this value to verify the acoustic beam atmosphere is "air" (344.1 m/s or 1129 ft/s).

Alternatively, if the acoustic beam atmosphere sound velocity at 20°C (68 °F) is known, and the sound velocity vs. temperature characteristics are similar to that of "air", enter the sound velocity.

The units used are m/s if P005 = 1, 2, or 3 (or ft/s if P005 = 4 or 5).

values: 50.01 to 2001 m/s (164.1 to 6563 ft/s)

TEMPERATURE COMPENSATION PARAMETERS (P660 to P664)

P660 TEMP SOURCE

This feature is preset to "AUTO".

The HYDRO+ measures the TS-3 temperature sensor assigned to the transducer. If a TS-3 sensor is not connected, the temperature measurement from the ultrasonic/temperature transducer is used. If the transducer used does not have an internal temperature sensor, the Temp Fixed (P661) value is used.

If the acoustic beam atmosphere temperature varies with distance from the transducer, connect a TS-3 Temperature Sensor and ultrasonic/ temperature transducers, and select "average".

values: 1 = AUTO
2 = Temp Fixed
3 = Ultrasonic/Temperature Transducer
4 = TS-3 Temperature Sensor
5 = Average

P661 TEMP FIXED

Use this feature if a temperature sensing device is not used.

Enter the temperature (in °C) of the atmosphere within the transducer acoustic beam. If the temperature varies with distance from the transducer, enter the average temperature.

values: -50 to 150 (preset = 20 °C)

P662 reserved

P663 TEMPERATURE TRANSDUCER ALLOCATION

This feature may only be used for "differential" or "average" Operation (P001 = 4 or 5).

As preset, the temperature measurements of Ultrasonic / Temperature Transducer # 1 and 2 are allocated to Point Number 1 and 2 respectively.

Use this feature (if desired) if the temperature measurement from both transducers should be identical, however one transducer is mounted in direct sunlight (or near some other radiant heat source). Allocate the temperature measurement of the other transducer to both transducer Point Numbers.

Enter the Transducer Number whose temperature measurement will be used for the distance calculation of the Point Number displayed.

When both transducers are allocated to a Point Number, the temperature measurements from each transducer are averaged.

values: 1 = Transducer # 1
2 = Transducer # 2
1.2 = Transducer # 1 and 2 average

P664 (V) TEMPERATURE

View the transducer acoustic beam atmosphere temperature in °C.

This is the value displayed when  is pressed in the RUN mode.

If Temp Source (P660) is set to any value other than Fixed Temp, the value displayed is the temperature measured. If Temp Source is set to Fixed Temp, the P661 value is displayed.

values: -50 to 150

RATE PARAMETERS (P700 to P707)

P700 MAX FILL RATE

Adjust the HYDRO+ response to increases in the actual material level (or advance to a higher Failsafe Material Level, P071).

Enter a value slightly greater than the maximum vessel filling rate.

This value, in Units (P005) or % of Span (P007) per minute, is automatically altered when Measurement Response (P003) is altered.

values: 0.000 to 9999

P701 MAX EMPTY RATE

Adjust the HYDRO+ response to decreases in the actual material level (or advance to a lower Failsafe Material Level, P071).

Enter a value slightly greater than the maximum vessel emptying rate.

This value, in Units (P005) or % of Span (P007) per minute, is automatically altered when Measurement Response (P003) is altered.

values: 0.000 to 9999

P702 FILLING INDICATOR

Enter the fill rate required to activate the LCD Filling indicator.

This value (in Units (P005) or % of Span (P007) per minute) is automatically set to 10% of the Max Fill Rate (P700).

values: -999 to 9999

P703 EMPTYING INDICATOR

Enter the empty rate required to activate the LCD Emptying indicator.

This value (in Units (P005) or % of Span (P007) per minute) is automatically set to 10% of the Max Empty Rate (P701) .

values: -999 to 9999

P704 RATE FILTER

Use this feature to avoid Rate Value (P707) fluctuations due to a "splashing" material surface.

This value is automatically altered when Measurement Response (P003) is altered. See **TECHNICAL REFERENCE** Measurement Response.

This value automatically alters the Rate Update Time (P705) and / or Rate Update Distance (P706). Alternatively, these parameter values may be altered independently.

Enter the time period/distance over which the Rate Value is to be averaged before display update.

values: 0 = rate display not required
 1 = continuously averaged and updated
 2 = 1 minute or 50 mm (2 in)
 3 = 5 minutes or 100 mm (3.9 in)
 4 = 10 minutes or 300 mm (11.8 in)
 5 = 10 minutes or 1000 mm (39.4 in)

P705 RATE UPDATE TIME

Enter the time period (in seconds) over which the material level rate of change is averaged before Rate Value update.

values: 0.000 to 9999

P706 RATE UPDATE DISTANCE

Enter the material level change (in metres) to initiate a Rate Value update.

values: 0.000 to 9999

P707 (V) RATE VALUE

View the rate of material level change (in Units (P005) or % of Span (P007) per minute).

(A negative rate indicates the vessel is emptying).

This is the value displayed when  is pressed in the RUN mode.

values: 0.000 to 9999

P708 VOLUME RATE DISPLAY

Displays the rate of change of volume in 'percent of maximum volume' per minute. This value is used internally to calculate inflow in pumped volume applications (P622 = 3 and P623 = 1).



 to toggle between percent and volume.

MEASUREMENT VERIFICATION PARAMETERS (P710 to P713)

P710 FUZZ FILTER

Use this feature to stabilize the reported level, due to level fluctuations (such as a rippling or splashing liquid surface), within the Echo Lock Window (P713).

This value (in % of Span, P007) is automatically altered when Measurement Response (P003) is altered.

The higher the value entered, the greater the fluctuation stabilized.

values: 0 to 100 (0 = off)

P711 ECHO LOCK

Use this feature to select the measurement verification process.

If a *material agitator* (mixer) is used in the vessel monitored, set Echo Lock for "maximum verification" or "material agitator", to avoid agitator blade detection. Ensure the agitator is always "on" while the HYDRO+ is monitoring the vessel, to avoid stationary blade detection.

When set for "max verification or material agitator", a new measurement outside of the Echo Lock Window (P713), must meet the sampling criterion (P712).

For "total lock", Echo Lock Window (P713) is preset to "0". The HYDRO+ continuously searches for the best echo according to the algorithm chosen (P820). If the selected echo is within the window, the window is then centered about the echo. If not, the window widens with each successive shot until the selected echo is within the window. The window then returns to its normal width.

When Echo Lock is "off", the HYDRO+ responds immediately to a new measurement as restricted by the Max Fill / Empty Rate (P700 / P701), however measurement reliability is affected.

values: 0 = off

1 = maximum verification

2 = material agitator

3 = total lock

P712 ECHO LOCK SAMPLING

The sampling criterion sets the number of consecutive echoes appearing above or below the echo currently locked onto, that must occur before the measurements are validated as the new reading (for Echo Lock P711 values: 1 or 2).

| <i>P711 value</i> | <i>P712 preset value</i> |
|----------------------|--------------------------|
| 1, max verification | 5:5 |
| 2, material agitator | 5:2 |

e.g. : P711 = 2, material agitator
P712 = 5:2

a new reading will not be validated unless 5 consecutive measurements higher or 2 consecutive measurements lower than the current reading occurs.

values: x.y x= # of 'above' echoes y = # of 'below' echoes

Resetting P711 returns P712 to the respective preset values.

P713 ECHO LOCK WINDOW

Use this feature to adjust the new measurement change permitted before Echo Lock is applied.

This value is automatically altered when Measurement Response (P003), Max Fill Rate (P700) or Max Empty Rate (P701) is altered.

The Echo Lock Window is a "distance window" (in Units, P005), placed about the echo used to derive the Reading. When a new measurement falls within the window, the window is recentered and the new Reading is calculated. Otherwise, the new measurement is verified by Echo Lock (P711) before the HYDRO+ updates the Reading.

When "0" is entered, the window is automatically calculated each time a measurement is made. The calculation is based on the Max Fill/Empty Rate (P700 / P701), (dependent upon current vessel filling / emptying activity), and the time since the last valid echo was processed.

For slower Measurement Response (P003) values, the calculated Echo Lock Window is narrow. For faster values the window becomes increasingly wider.

values: 0.000 to 9999

SCANNING PARAMETERS (P726 to P728)

P726 (G) LEVEL SYSTEM SYNC

Use this feature if another level measurement system is mounted near the HYDRO+.

See **INSTALLATION** Interconnection/Level System Synchronization.

values: 0 = not required
1 = synchronize level monitors (preset)

P727 (G) SCAN DELAY

This feature may only be used for "differential" or "average" Operation (P001 = 4 or 5), to adjust the delay before the next point is scanned.

Enter the amount of delay in seconds. This value is automatically altered when Measurement Response (P003) is altered.

values: -999 to 9999

P728 SHOT DELAY

Use this feature if transient acoustic noise within the vessel is causing measurement difficulties.

Enter the delay (in seconds) between transmit pulse shots.

values: 0.1 to 4.0 (preset = 0.5 seconds)

P729 SCAN TIME

View the elapsed time (in seconds) since the point displayed was last scanned. This value may be viewed as an Auxiliary Reading in the RUN mode, and is particularly useful when "differential" or "average" Operation (P001 = 4 or 5) is selected.

values: 0.000 to 9999

DISPLAY PARAMETERS (P730 to P733, P740)





P730 (G) AUXILIARY READING

Use this feature to display operator selected Auxiliary Readings temporarily or indefinitely (as desired).

Select "OFF" to display Auxiliary Readings temporarily. Select "HOLD" to display Auxiliary Readings until another Auxiliary Reading is selected.

(See **OPERATION** Keypad for RUN mode Auxiliary Reading selection.)

To select the Auxiliary Reading operation desired...

1.  to display the Auxiliary Function symbol.
2.  or  to access the "OFF" or "HOLD" option desired.
3. 

If desired, also enter the Parameter Number to default in the Auxiliary Reading display.

values: 000 to 999

P731 (G) AUXILIARY READING KEY

Enter the Parameter Number whose value is to be displayed in the Auxiliary Reading field when...

 is pressed in the RUN mode.

(See **OPERATION** Keypad for RUN mode Auxiliary Reading selection.)

values: 000 to 999 (preset to Material Reading, P921)

P732(G) DISPLAY DELAY

Adjusts the Point Number display scroll speed.

Use this feature (if desired) when "differential" or "average" Operation (P001 = 4 or 5) is selected, to adjust the delay (in seconds) before the display advances to the next Point Number.

(Display scrolling is independent from transducer scanning.)

values: 0.5 to 10 (preset to 1.5 seconds)

P733 (G) SCROLL ACCESS

Use this feature to select the parameter scroll access option desired.

Select: "off" to scroll access all parameters (P000 to P999).

"smart" for Quick Start, altered, and tagged parameters.

"tagged" to scroll access operator tagged parameters only.

(  to tag / untag any accessed parameter).



is displayed to indicate the parameter accessed is tagged.

values: 0 = off

1 = smart (preset)

2 = tagged

P737 (G) PRIMARY READING

Use this feature to select the parameter primary reading option desired.

When this value indicates toggle, then both readings (default and totalizer) are shown in the time specified in display delay (P732).

values: 1 = default reading (P920) based on operation (P001) (preset)

2 = LCD Totalizer (P322, P323)

3 = automatically toggle between 1 and 2

ECHO PROCESSING PARAMETERS (P800 to P807)

P800 NEAR BLANKING

Use this feature if the surface monitored is incorrectly reported to be near the transducer face.

Near Blanking (the distance from the transducer face which is not ultrasonically measurable) is preset to a value depending on the transducer selected (P004).

| <i>blanking</i> | <i>transducer</i> |
|-----------------|------------------------------------|
| 0.3 m (1.0 ft) | ST-25, ST-50, ST-H, XPS-10, XPS-15 |
| 0.45 m (1.5 ft) | XCT-8, XCT-12 |

Extend Near Blanking to overcome measurement difficulties which cannot be corrected by transducer relocation, mounting, or aiming.

The causes of measurement difficulties which may be corrected include:

- » a vessel obstruction partly blocking the transducer acoustic beam.
- » a transducer standpipe mount that is too narrow for its length.
- » a transducer mounting which is resonant at the transducer frequency.

Extend Near Blanking 150 mm (6 in) beyond the incorrect distance reported.

**Do not reduce Near Blanking to less than the preset value.
Ensure Near Blanking is less than Empty (P006) - Span (P007).**

values: 0.000 to 9999

P801 RANGE EXTENSION

Use this feature if the surface monitored is incorrectly reported when the material level is lower than Empty (P006).

Range Extension (the distance beyond Empty which is still ultrasonically measurable) is preset to 20% of Span (P007).

Ensure the % Symbol is displayed before attempting to enter a % of Span value. (See **PROGRAMMING** Keypad).

If the surface monitored can extend beyond Empty (P006), increase Range Extension (in Units (P005) or % of Span) such that Empty plus Range Extension is greater than the transducer face to furthest surface to be monitored distance.

values: 0.000 to 9999

P802 SUBMERGENCE SHIELD ON TRANSDUCER

Use this feature (if desired) when the transducer connected is equipped with a submergence shield.

When the transducer is submerged, the HYDRO+ detects that the monitored surface is within the Near Blanking (P800) distance, and immediately advances to " zero " distance, operating displays and outputs accordingly.

values: 0 = off (preset)

1 = submergence transducer

P803 SHOT / PULSE MODE

Use this feature (if desired) to increase HYDRO+ response when the monitored surface is close to the transducer face.

Select "short and long" to have short and long acoustic shots fired for each measurement, regardless of the transducer to surface distance.

Select "short" to have only short shots fired if the Echo Confidence (P805) produced by a short shot exceeds the short Confidence Threshold (P804) and the monitored surface is within the Short Shot Range (P852).

values: 1 = short

2 = short and long (preset)

P804 CONFIDENCE THRESHOLD



Use this feature when an incorrect material level is reported.

The short and long shot Confidence Thresholds are preset to 10 and 5 respectively. When Echo Confidence (P805) exceeds the Confidence Threshold, the echo is evaluated by **Sonic Intelligence™**.

values: x.y x = short (0 to 99), y = long (0 to 99)

P805 (V) ECHO CONFIDENCE

Use this feature to monitor the effect of transducer aiming, location, and mechanical transducer / mounting isolation.

Both short and long shot Echo Confidence is displayed. (To display this value in the RUN mode,   for 4 seconds).

| Display | Description |
|---------|--|
| "x:--" | short shot confidence value, (long shot not used). |
| "--:y" | long shot confidence value, (short shot not used). |
| "x:y" | short and long shot confidence values (both used). |
| "E" | transducer cable is open or short circuited. |
| "--:--" | no shots were processed for Sonic Intelligence™ evaluation. |

values: x:y x = short (0 to 99), y = long (0 to 99)

P806 (V) ECHO STRENGTH

Use this feature to view the strength (in dB above 1 uV RMS) of the echo selected to base the distance calculation upon.

values: 0 to 99

P807 (V) NOISE

Observe the average and peak ambient noise (in dB above 1 uV RMS) being processed.

The noise level is a combination of transient acoustic noise and electrical noise (induced into the transducer cable or receiving circuitry).

values: x.y x = average (-99 to 99), y = peak (-99 to 99)

ADVANCED ECHO PROCESSING PARAMETERS (P810,P816-P825)

The following parameters are for authorized Milltronics Service personnel or Instrumentation Technicians familiar with Milltronics echo processing techniques.

P810 SCOPE DISPLAYS

Use this feature to monitor Echo Processing alteration effects.

Connect an oscilloscope to Display Board TP1, TP2, and TP3.

Sweep = 10 us / div. to 1 ms / div. (x 100 for real time)

Amplitude = 1 V / div.

Trigger = external

Observe any combination of the following Scope Displays:

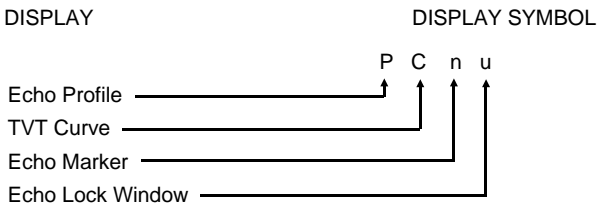

To select the Scope Display desired...



to display the Auxiliary Function symbol,



or  to scroll access the desired Reading display symbols.



with the desired display symbols displayed.

Alternatively, a 4 digit binary value may be entered, where a "0" turns the associated signal display "off", and a "1" turns the display "on".

e.g. 1110 = PCn_ = Echo Profile, TVT Curve, and Echo Marker displays on, Echo Lock Window display off.

See **TECHNICAL REFERENCE** Echo Processing for illustration.

Use the Scope Displays after  (in the program mode) to observe the result of Echo Processing parameter alterations. (Take several measurements to verify measurement repeatability and overcome Echo Lock (P711) restrictions).

As preset, all displays are off.

P816 (V) ECHO TIME

Observe the time (in ms) from the transmit pulse to the echo processed.



values: 0.000 to 9999

PROFILE POINTER PARAMETERS

When a Profile Pointer Parameter is accessed, the Echo Lock Window scope display changes to a Profile Pointer display. The Profile Pointer may be moved to a number of points on the Echo Profile, to gain specific information dependent upon the Profile Pointer Parameter used.

To move the Profile Pointer to a specific point, enter the desired value. The Profile Pointer will move to the nearest acceptable Echo Profile point. The Profile Pointer is preset to "0".

Alternatively, to scroll the Profile Pointer along the Echo Profile...

1.  to display the Auxiliary Function symbol,
2.  or  to move the Profile Pointer to the left or right respectively.

When the Profile Pointer Parameters are exited and  is pressed or the RUN mode is entered, the Profile Pointer display automatically changes back to the Echo Lock Window display.

P817 (V) PROFILE POINTER TIME

Observe the time (in ms) from the transmit pulse to the Profile Pointer.

values: 0.000 to 9999

P818 (V) PROFILE POINTER DISTANCE

Observe the distance (in P005 Units) between the transducer face and the Profile Pointer.

values: 0.000 to 9999

P819 (V) PROFILE POINTER AMPLITUDE

Observe the amplitude (in dB above 1 μ V) of the Echo Profile at the Profile Pointer position.







values: 0 to 99

P820 ALGORITHM

Use this feature to select the *Algorithm(s)* (mathematical operations) which the **Sonic Intelligence™** echo selection is to be based on.

If the wrong echo is processed, select an alternate algorithm, while observing the resultant echo processing displays.

To select an Algorithm...

1.   to display the Auxiliary Function symbol,
2.   or  to display the desired Reading display symbol(s),
3.   (when the desired Algorithm is displayed)

Alternatively, enter the value desired.

- values:
- 1 = ALF = flat Area, Largest, and First average
 - 2 = A = flat Area only
 - 3 = L = flat Largest only
 - 4 = F = flat First only
 - 5 = AL = flat Area and Largest average
 - 6 = AF = flat Area and First average
 - 7 = LF = flat Largest and First average
 - 8 = bLF = smooth Largest or First (preset)
 - 9 = bL = smooth Largest only
 - 10 = bF = smooth First only

P821 SPIKE FILTER

Activate the Spike Filter if interference spikes are observed on the long shot Echo Profile display.

- values:
- 0 = off
 - 1 = on (preset)

P822 NARROW ECHO FILTER

Use this feature, when monitoring solids (P002 = 2) only, if transducer acoustic beam interference (e.g. ladder rungs) is processed.

Enter the width of false echoes (in ms), to be removed from the long shot Echo Profile.

When a value is keyed in, the nearest acceptable value is entered.

- values: 0 = off (preset), greater = wider

P823 REFORM ECHO

Use this feature, when monitoring solids (P002 = 2), if the reported level fluctuates slightly, though the monitored surface is still).

Enter the amount (in ms) of long shot Echo Profile smoothing required to eliminate jagged peaks in the Echo Profile.

When a value is keyed in, the nearest acceptable value is entered.

values: 0 = off (preset), greater = wider

P825 ECHO MARKER TRIGGER

Use this feature if the reported material level fluctuates slightly, due to a variable rise in the leading edge of the true echo on the Echo Profile.

Enter the value (in percent of echo height) to ensure the Echo Lock Window intersects the Echo Profile at the sharpest rising portion of the Echo Profile representing the true echo. This value is preset to 90% if P002 = 1 (Liquids), or 50% if P002 = 2 (Solids).

values: 5 to 95

ADVANCED TVT ADJUSTMENT (P830 to P835)

P830 TVT TYPE

Use this feature to select the TVT Curve desired.

This feature is automatically altered when Material (P002) is altered. Do not use "TVT Slopes" with the "bF" or "bLF" Algorithm (P820).

values: 1 = TVT Short Curved
2 = TVT Short Flat
3 = TVT Long Flat
4 = TVT Long Smooth Front
5 = TVT Long Smooth
6 = TVT Slopes

P831 TVT SHAPER

Use this feature to turn the TVT Shaper "on" or "off".

Turn the TVT Shaper "on" before altering TVT Shaper Adjust. After using TVT Shaper Adjust (to avoid a false echo or pick up the true echo), turn the TVT Shaper "on" and "off" while monitoring the effect.

values: 0 = off
1 = on

P832 TVT SHAPER ADJUST

Use this feature to bias the shape of the TVT curve, in order to avoid it crossing false echoes from fixed objects.

Adjustment to this parameter is best done while viewing the echo profile on an oscilloscope (refer to P810). When using an oscilloscope, the Echo Lock Window display becomes the TVT Curve Pointer.

The TVT curve is divided into 40 breakpoints, accessible by enabling the point number as the breakpoint index field. Each breakpoint is normalized to a value of 0, as displayed in the parameter value field. By changing the breakpoint value, up or down, the intensity of the bias applied to that breakpoint of the curve is respectively changed. By changing the value of adjacent breakpoints, the effective bias to the shaper can be broadened to suit the desired correction. In the case of multiple false echoes, shaping can be applied along different points of the curve. Shaping should be applied sparingly in order to avoid missing the true echo.

To change a breakpoint ...

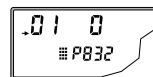

e.g. index, breakpoint 1, value 0



 selects the Auxiliary function



auxiliary function



scrolls the breakpoint index through points 1 to 40, and moves the curve pointer left or right respectively.

.05 0
P832

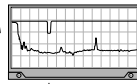

e.g. oscilloscope displays breakpoint 5,

And,



changes the bias value of the breakpoint, -50 to 50

.05 14
P832

e.g. breakpoint 5, value



enters the change in value.

.05 14
P832

P831, TVT shaper, must be 'on'.

P833 TVT START MIN

Use this feature to adjust the TVT Curve height to ignore false echoes (or pick up true echoes) near the start of the Echo Profile.

Enter the minimum TVT Curve start point (in dB above 1 uV RMS).

This feature should only be used if increased Near Blanking (P800) would extend farther than desired into the measurement range.

values: -30 to 225 (preset = 45)

P834 TVT START DURATION

Use this feature in conjunction with TVT Start Min (P833) to ignore false echoes (or pick up true echoes) near the start of the Echo Profile.

Enter the time (in ms) for the TVT Curve to decrease from the TVT Start Min (P833) point to the TVT Curve baseline.

values: 0 to 9999 (preset = 30)

P835 TVT SLOPE MIN

Enter the minimum slope (in dB/s) for the middle of the TVT Curve.

This feature (preset to 200) is used in conjunction with TVT Start Duration (when a long flat TVT Type is selected) to ensure the TVT Curve remains above false echoes which appear in the middle of the Echo Profile.

Alternatively, if TVT Type is set for "TVT Slopes" (P830 = 6), this value is preset to 2000. Use this feature to adjust the slope declination, as required.

values: 0 to 9999 (preset = 200)

ADVANCED SHOT ADJUSTMENT (P840-P845, P850 to P852)

P840 SHORT SHOT NUMBER

Enter the number of short shots to be fired (and results averaged) per transmit pulse.

values: 0 to 100

P841 LONG SHOT NUMBER

Enter the number of long shots to be fired (and results averaged) per transmit pulse.

This value is automatically altered by Measurement Response (P003).

values: 0 to 200

P842 SHORT SHOT FREQUENCY

Adjust the short shot transmit pulse frequency (in kHz).

This feature is automatically altered when Transducer (P004) is altered.

values: 10.00 to 60.00

P843 LONG SHOT FREQUENCY

Adjust the long shot transmit pulse frequency (in kHz).

This feature is automatically altered when Transducer (P004) is altered.

values: 10.00 to 60.00

P844 SHORT SHOT WIDTH

Adjust the width (in ms) of the short shot transmit pulse.

This feature is automatically altered when Transducer (P004) is altered.

values: 0.000 to 5.000

P845 LONG SHOT WIDTH

Adjust the width (in ms) of the long shot transmit pulse.

This feature is automatically altered when Transducer (P004) is altered.

values: 0.000 to 5.000

P850 SHORT SHOT BIAS

Use this feature to slant the echo evaluation in favour of the short shot echo when both short and long shots are evaluated (see Shot Mode, P803). This feature is preset to 20.

values: 0 to 100

P851 SHORT SHOT FLOOR

Enter the minimum echo strength (in dB above 1 μ V), derived from a short shot, to be considered for evaluation. This feature is preset to 50.

values: 0 to 100

P852 SHORT SHOT RANGE

Enter the maximum distance in Units (P005) to be measured using short shot echoes.

This feature is automatically altered when Transducer (P004) is altered.

values: 0.000 to 9999

TEST PARAMETERS (P900 to P913)

Test Parameters are intended for use by Milltronics Service personnel.

P900 (V) SOFTWARE REV.

View the EPROM Rev. # without removing the enclosure lid.

values: 00.00 to 99.99

P901 (V) MEMORY

 to activate the HYDRO+ memory test.

values: PASS (memory test successful)

F1 = RAM

F3 = EEPROM

F2 = NOVDRAM

F4 = EPROM

P902 (V) WATCHDOG

 to reset the microprocessor.

On successful completion (10 seconds) the RUN mode is entered.

P903 (V) DISPLAY

 to activate the display test.

All LCD segments and symbols are temporarily displayed.

P904 (G) KEYPAD

Press each keypad key in the following sequence:



As each key is pressed, the associated keypad number is displayed. On successful test completion, "PASS" is displayed. "FAIL" is displayed if a key is pressed out of sequence or the programmer keypad malfunctions.

P905 TRANSMIT PULSE

 to supply repeated transmit pulses to the transducer and / or view the transducer operating frequency (automatically altered by (P004) Transducer) for the Point Number displayed.

This feature may be used to monitor the transmit pulse with an oscilloscope connected to the transducer terminals.

values: 10.00 to 60.00

P907 PROGRAMMER INTERFACE

 to activate the programmer interface (two way infrared communications) test.

On successful test completion, "PASS" is displayed. Otherwise, "FAIL" is displayed.

P910 RELAY

Access this parameter to display the current state of the specified relay.

 to alter the relay state (energized / de-energized) or enter the value corresponding to the specific relay state desired.

values: 0 = de-energized

1 = energized

P911 mA OUTPUT VALUE

Access this parameter to display the current value of the mA output.

Additionally, this feature may be used to enter a desired value. The mA output immediately assumes the value entered regardless of any restrictions programmed.

values: 0.000 to 25.00

P912 TRANSDUCER TEMPERATURE

Use this feature to display the temperature in °C (as monitored by the connected transducer). "Err" is displayed if the transducer is not equipped with an internal temperature sensor.

values: -50 to 150

P913 SENSOR TEMPERATURE

Access this parameter to display the temperature in °C (as monitored by the TS-3). "OPEn" is displayed if a TS-3 is not connected.

values: -50 to 150

P914 mA INPUT

Use this feature to display the mA input value (in mA).

values: 0.000 to 22.00

MEASUREMENT PARAMETERS (P920 to P926)



Use these features to verify HYDRO+ programming.

If HYDRO+ operation has not been verified, disable all associated process control equipment before accessing the following parameters.

Access the parameter desired and press ; repeat 5 times to overcome Echo Lock (P711), if applicable. The associated Reading is displayed in the Parameter Value field, and the mA output and "alarm" relays are set accordingly.



"Pump" and "control" relays are held "off" (however the relay display symbols are active) unless Lock is set for "Simulation Controls" (P000 = -1).

To start a (P920, P921, P922, or P923) simulation (from level = 0)...



  to simulate level rise and fall at 1% of Span / second.

Use the  and  keys to adjust the simulated rate of rise or fall.



Rise at 4% of Span/second

 or 



Rise at 1% of Span/second

 or 

STOP



 or 



Fall at 1% of Span/second

 or 

Fall at 4% of Span/second

To verify Reading calculations (P920 to P926)...

1. Key in a material level in Units (P005) or % of Span (P007).
2.  , calculated Reading is displayed.
3. Verify the calculated Reading.

To start a simulation from the level entered,   or .

(Display the % symbol before entering a % value, see **PROGRAMMING** Keypad).

P920 READING MEASUREMENT

The Reading corresponds to all associated programming after  is pressed or during simulation.

P921 MATERIAL MEASUREMENT

The Reading corresponds to the distance between Empty (P006) and the monitored surface after  is pressed, or during simulation.

P922 SPACE MEASUREMENT

The Reading corresponds to the distance between the monitored surface and Span (P007) after  is pressed, or during simulation.

P923 DISTANCE MEASUREMENT

The Reading corresponds to the distance between the monitored surface and the transducer face, after  is pressed or during simulation.

P924 VOLUME MEASUREMENT

The Reading corresponds to the calculated vessel capacity utilized (not remaining), after  is pressed, displayed in Max Volume (P051) units or % of Max Volume.

P925 FLOW MEASUREMENT

The Reading corresponds to the calculated flowrate, after  is pressed, in Max Flow (P604) units or % of Max Flow.

P926 HEAD MEASUREMENT

The Reading corresponds to *Head* (the distance from Min Head (P605) to the monitored surface), after  is pressed, in Units (P005) or % of Span (P007).

P927 DISTANCE PERCENT

Same as P923, plus alternate reading in %   .

MASTER RESET (P999)

P999 MASTER RESET

This feature resets all parameters to original values.

When performing a Master Reset, the bar graphic will indicate progress from 0 to 100%.

Use this feature prior to initial programming if arbitrary Parameter Values were used during a "bench test", or after replacing the HYDRO+ EPROM with a different software revision number.

Following a Master Reset, complete reprogramming is required.

To perform a Master Reset..



"C.ALL" is displayed until the reset is complete.

TECHNICAL REFERENCE

TRANSMIT PULSE

The HYDRO+ transmit pulse consists of one or more electrical "shot" pulses, which are supplied to the Transducer connected to the HYDRO+ terminals.

The transducer fires an acoustic "shot" for each electrical pulse supplied. After each shot is fired, sufficient time is provided for *echo* (shot reflection) reception, before the next (if applicable) shot is fired. After all shots of the transmit pulse are fired, the resultant echoes are processed.

The transmit pulse shot number, frequency, duration, delay, and associated measurement range are defined by parameters P803 and P840 to P852.

ECHO PROCESSING

Echo processing consists of echo enhancement, true echo selection, and selected echo verification.

Echo Enhancement is achieved by *filtering* (P821 and P822) and *reforming* (P823) the *echo profile* (P810).

The *true echo* (echo reflected by the intended target) is selected when that portion of the echo profile meets the evaluation criteria of **Sonic Intelligence™**.

Insignificant portions of the echo profile outside of the measurement range (Span P006 + Range Extension P801), below the TVT Curve (P830, and P832 to P835), and less than the Confidence Threshold (P804) and Short Shot Floor (P851) are automatically disregarded.

The remaining portions of the Echo Profile are evaluated using the Algorithm (P820) and Short Shot Bias (P850). The Echo Profile portion providing the best Echo Confidence (P805), is selected.

True echo verification is automatic. The position (relation in time after transmit) of the "new" echo, to the previously accepted echo position, is compared. When the new echo is within the Echo Lock Window (P713), it is accepted and displays, outputs, and relays are updated per the Fuzz Filter (P710) and Rate Parameters (P700 to P703). If the new echo is outside of the Echo Lock Window, it is not accepted until *Echo Lock* (P711) requirements are satisfied.

SCOPE DISPLAYS (P810)

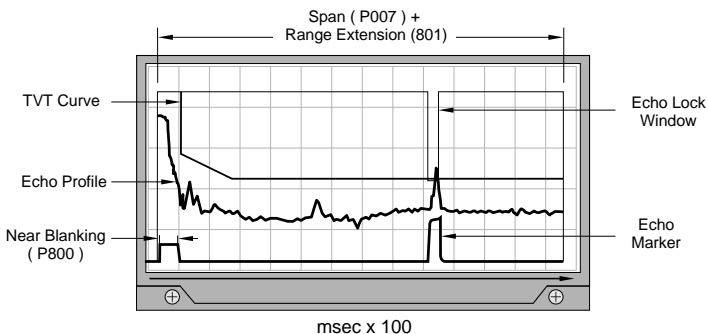

DISTANCE CALCULATION

To calculate the transducer to material level (object) distance, the *transmission medium* (atmosphere) sound velocity (P653) is multiplied by the acoustic transmission to reception time period. This result is divided by 2 to calculate the "one way" distance.

$$\text{Distance} = \frac{\text{Sound Velocity} \times \text{Time}}{2}$$

The Reading displayed is the result of performing any additional modification to the calculated distance (as determined by Operation P001, Units P005, Volume Conversion, P050 to P054, Reading, P060 to P063, OCM, P600 to P611, and/or Totalizer P622 to P633 parameters).

SOUND VELOCITY

The sound velocity of the transmission medium is affected by the type, temperature, and vapour pressure of the gas or vapour present. As preset, the HYDRO+ assumes the vessel atmosphere is air at 20 °C (68 °F). Unless altered, the sound velocity used for the distance calculation is 344.1 m / s (1129 ft / s).

Variable air temperature is automatically compensated when a Milltronics ultrasonic / temperature transducer is used. If the transducer is exposed to direct sunlight, use a sunshield or better yet, a separate TS-3 temperature sensor.

Also, if the temperature varies between the transducer face and the liquid monitored, use a TS-3 temperature sensor, (submerged in the liquid) in combination with an ultrasonic / temperature transducer. Set Temp Source (P660) for "both", to average the transducer and TS-3 temperature measurements.

Atmosphere composition other than air can pose a challenge for ultrasonic level measurement. However, excellent results may be obtained if the atmosphere is *homogeneous* (well mixed), at a fixed temperature, and consistent vapour pressure, by performing a Sound Velocity Calibration (P651).

The HYDRO+ automatic temperature compensation is based on the sound velocity / temperature characteristics of "air" and may not be suitable for the atmosphere present. If the atmosphere temperature is variable, perform frequent Sound Velocity Calibrations to maintain optimum measurement accuracy.

Sound Velocity calibration frequency may be determined with experience. If the sound velocity in two or more vessels is always similar, future calibrations may be performed on one vessel and the resultant Velocity (P653) entered directly for the other vessel(s).

If the sound velocity of a vessel atmosphere is found to be repeatable at specific temperatures, a chart or curve may be developed. Then, rather than performing a Sound Velocity Calibration each time the vessel temperature changes significantly, the anticipated Velocity (P-653) may be entered directly.

SCANNING

When the HYDRO+ is programmed for "differential" or "average" level Operation (P001 = 4 or 5), two transducers must be used. In this case, the transmit pulse is time shared between the transducers via the "Scanner" relay. See **INSTALLATION** Interconnection \ Transducer, and **PARAMETERS** Relay Function (P111).

When echo processing is complete, (if more than 1 vessel is monitored) the scanning relay changes state to supply the transmit pulse to the other transducer after the Scan Delay (P727).

Scan Delay is automatically set by Measurement Response (P003). When high speed scanning is required (sometimes the case for equipment position monitoring), the Scan Delay may be reduced. Reduce the Scan Delay only as required, otherwise premature scanning relay fatigue could occur.

VOLUME CALCULATION

The HYDRO+ provides a variety of volume calculation features (P050 to P055).

If the vessel does not match any of the 8 preset Tank Shape calculations, a Universal Volume calculation may be used. Use the level/volume graph or chart provided by the vessel fabricator (or create one based on the vessel dimensions).

Based on the graph, choose the Universal Volume calculation, and select the level vs volume breakpoints to be entered (32 max). Generally, the more breakpoints entered, the greater the volume calculation accuracy.

Universal, Linear (P050 = 9)

This volume calculation creates a piece-wise linear approximation of the level/volume curve. This option provides best results if the curve has sharp angles joining relatively linear sections.

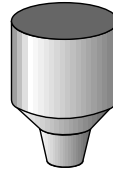
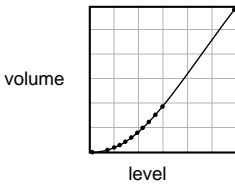

Enter a Level Breakpoint at each point where the level/volume curve bends sharply (2 minimum).

For combination curves (mostly linear but include 1 or more arcs), enter numerous breakpoints along the arc, for best volume calculation accuracy.

Universal, Curved (P050 = 10)

This calculation creates a cubic spline approximation of the level/volume curve, providing best results if the curve is non-linear, and there are no sharp angles.

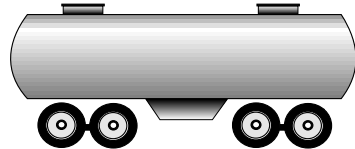
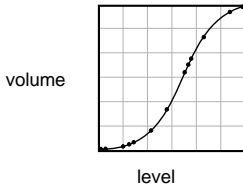

Select at least enough breakpoints from the curve to satisfy the following:

- » 2 breakpoints very near the minimum level
- » 1 breakpoint at the tangent points of each arc
- » 1 breakpoint at each arc apex
- » 2 breakpoints very near the maximum level

For combination curves, enter at least 2 breakpoints immediately before and after any sharp angle (as well as 1 breakpoint exactly at the angle) on the curve.

FLOW CALCULATION

The HYDRO+ provides numerous OCM flow calculation features (P600 to P611).

If the *PMD* (primary measuring device) does not match any of the 8 preset *PMD* calculations, or if a *PMD* is not used, select a Universal Volume calculation. Use the head/flow graph or chart provided by the *PMD* fabricator (or create one based on the *PMD* or channel dimensions).

Based on the graph, choose the Universal Flow calculation, and select the head vs flow breakpoints to be entered (32 max). Generally, the more breakpoints entered, the greater the flow calculation accuracy.

Universal, Linear (P600 = 4)

This flow calculation creates a piece-wise linear approximation of the head/flow curve. This option provides best results if the curve has sharp angles joining relatively linear sections.

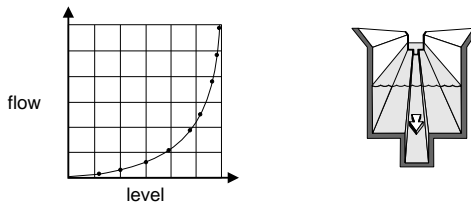

Enter a Head Breakpoint at each point where the head/flow curve bends sharply (2 minimum). For combination curves (mostly linear but include 1 or more arcs), enter numerous breakpoints along the arc, for best flow calculation accuracy.

Universal, Curved (P600 = 5)

This calculation creates a cubic spline approximation of the head/flow curve, providing best results if the curve is non-linear, and there are no sharp angles.

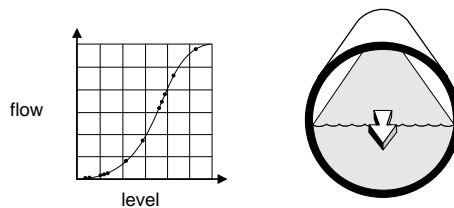

Select at least enough breakpoints from the curve to satisfy the following:

- » 2 breakpoints very near the minimum head
- » 1 breakpoint at the tangent points of each arc
- » 1 breakpoint at each arc apex
- » 2 breakpoints very near the maximum head

For combination curves, enter at least 2 breakpoints immediately before and after any sharp angle (as well as 1 breakpoint exactly at the angle) on the curve.

MEASUREMENT RESPONSE

The HYDRO+ Measurement Response (P003) to material level changes is designed to exceed even the most demanding installation requirements.

The Measurement Response setting automatically presets various parameters affecting the HYDRO+ response to material level changes as follows:

| Parameter (units) | Values Dependent on Measurement Response (P003) | | |
|---------------------------------|--|-----------|---------|
| | 1(slow) | 2(medium) | 3(fast) |
| P070 Failsafe Timer (min) | 100 | 10 | 1 |
| P700 Max Fill Rate (m/min) | 0.1 | 1 | 10 |
| P701 Max Empty Rate (m/min) | 0.1 | 1 | 10 |
| P702 Filling Indicator (m/min) | 0.01 | 0.1 | 1 |
| P703 Emptying Indicator (m/min) | 0.01 | 0.1 | 1 |
| P704 Rate Filter (option) | 4 | 2 | 2 |
| P710 Fuzz Filter (% of Span) | 100 | 50 | 10 |
| P713 Echo Lock Window | (per P701 / P702 and time since last valid measurement). | | |
| P727 Scan Delay (s) | 5 | 5 | 3 |
| P841 Long Shot Number | 10 | 5 | 2 |

If any of these parameters are independently altered, a Measurement Response parameter alteration automatically resets the independently altered value.

Slower Measurement Response provides greater measurement reliability. Faster independently set Max Fill/Empty Rates may be impeded by Echo Lock, Scan Delay and Shot Delay values.

RELAY SET UP

The HYDRO+ Relay alarm/control/pump control features are designed to exceed even the most demanding installation requirements often eliminating the necessity of a Programmable Logic Controller (PLC).

The Relay Set Up (P100) setting automatically presets various parameters affecting the HYDRO+ relay operation as follows:

| SET UP | DESCRIPTION | RELAY NUMBER | P110 | P111 | P112 | P113 | P121 |
|--------|----------------|--------------|------|--------|------------------|------------------|------|
| 1 | Wet Well 1 | 1 | 1 | 52 | 70% ¹ | 20% ¹ | 0 |
| | | 2 | 1 | 52 | 80% ¹ | 20% ¹ | 0 |
| | | 3 | 1 | 1 - H | 90% | 85% | ---- |
| | | 4 | 1 | 1 - L | 10% | 15% | ---- |
| | | 5 | 1 | 0 | ---- | ---- | ---- |
| 2 | Wet Well 2 | 1 | 1 | 52 | 80% | 20% | 1 |
| | | 2 | 1 | 52 | 80% | 20% | 1 |
| | | 3 | 1 | 1 - H | 90% | 85% | ---- |
| | | 4 | 1 | 1 - L | 10% | 15% | ---- |
| | | 5 | 1 | 0 | ---- | ---- | ---- |
| 3 | Reservoir 1 | 1 | 1 | 52 | 30% ¹ | 80% ¹ | 0 |
| | | 2 | 1 | 52 | 20% ¹ | 80% ¹ | 0 |
| | | 3 | 1 | 1 - H | 90% | 85% | ---- |
| | | 4 | 1 | 1 - L | 10% | 15% | ---- |
| | | 5 | 1 | 0 | ---- | ---- | ---- |
| 4 | Reservoir 2 | 1 | 1 | 52 | 20% | 80% | 1 |
| | | 2 | 1 | 52 | 20% | 80% | 1 |
| | | 3 | 1 | 1 - H | 90% | 85% | ---- |
| | | 4 | 1 | 1 - L | 10% | 15% | ---- |
| | | 5 | 1 | 0 | ---- | ---- | ---- |
| 5 | Rake Control | 1 | 3 | 50 | 80% | 20% | 0 |
| | | 2 | 1 | 1 - H | 90% | 85% | ---- |
| | | 3 | 2 | 1 - L | 10% | 15% | ---- |
| | | 4 | 3 | 1 - H | 90% | 10% | ---- |
| | | 5 | 1 | 49 | ---- | ---- | ---- |
| 6 | General Alarms | 1 | 1 | 1 - H | 80% | 75% | ---- |
| | | 2 | 1 | 1 - L | 20% | 25% | ---- |
| | | 3 | 1 | 1 - HH | 90% | 85% | ---- |
| | | 4 | 1 | 1 - LL | 10% | 15% | ---- |
| | | 5 | 1 | 0 | ---- | ---- | ---- |

¹ The P112/P113 values alternate between all relays set for P111 = 52 (alternate assist pump control), each time the last running pump is shut off.

MAINTENANCE

The HYDRO+ uses a clock module* for time and date calculations required in features such as pump control and logging. It has a ten year life expectancy, and thus should be replaced at that time.

Otherwise the HYDRO + requires no maintenance, however a program of periodic checks is advised.

The enclosure should be cleaned if necessary. Use a vacuum cleaner and a clean, dry brush.

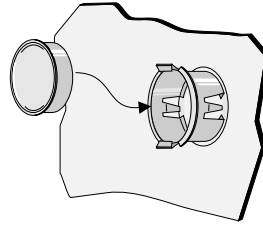

Disconnect the power before replacing clock module.

* Replace clock module with, Dallas DS1494L-F5.

TROUBLESHOOTING

TROUBLESHOOTING CHART

| SYMPTOM | CAUSE | ACTION |
|---|---|---|
| Display blank, Transmit Neon not flashing, transducer not pulsing. | No power. | Check power supply, wiring, ac selection switch positions, power fuse F4 or F5. |
| No response to programmer. | Obstructed infrared interface, or defective programmer. | Clean enclosure "docking bay" and programmer magnet slot. |
| Displays "Short" and " tb:(#)". | Short circuited transducer cable, or defective transducer. | Repair or replace as necessary. |
| Displays "Open" and " tb:(#)". | Transducer not connected | Correct transducer, or remove Point # from service (P001 = 0). |
| | Open circuited transducer cable, or defective transducer. | Repair or replace as necessary. |
| Displays "Error" and " tb:(#)". | Transducer connected wrong. | Reverse BLK and WHT wires. |
| | Wrong Transducer (P004). | Enter correct value. |
| Displays "LOE". | Weak or non-existent echo. | Relocate and/or re-aim transducer at material level or object. |
| | | Proceed to Measurement Difficulties. |
| Displays "EEEE". | Reading too high. | Select larger Units (P005), or lower Convert Reading (P061). |
| Reading fluctuates while material level is still, (or vice versa). | Incorrect measurement stabilization. | Alter Measurement Response (P003) accordingly. |
| | | See Technical Reference / Measurement Response. |
| Reading is fixed, regardless of the actual material level. | Transducer acoustic beam obstructed, standpipe too narrow, or transducer mounting resonant. | Relocate and / or re-aim transducer at material level or object. |
| | | Proceed to Measurement Difficulties. |
| Material level reported is always "off" by the same amount. | Incorrect Empty (zero) reference. | See Empty (P006), Reading Offset (P063), Offset Calibration (P650), & Offset Correction (P652). |
| Measurement accuracy improves as level nears transducer. | Incorrect Sound Velocity used for distance calculation. | Use an ultrasonic / temperature transducer or a TS-3 temp. sensor. |
| | | See TECHNICAL REFERENCE Sound Velocity. |
| Reading is erratic, with little or no relation to material level. | True echo too weak or wrong echo being processed. | Relocate and / or re-aim transducer at material level or object. |
| | | Proceed to Measurement Difficulties. |
| Date & time (P008 & P009) are fixed at 70:01:01 & 00:00:00 respectively | clock module life has expired | replace |

MEASUREMENT DIFFICULTIES

If the Failsafe Timer (P070) expires due to a measurement difficulty, "LOE" flashes alternately with the Reading. In rare cases, the HYDRO+ may "lock on" to a false echo and report a fixed or wrong Reading.

FLASHING "LOE" DISPLAY

If "LOE" is displayed, ensure the:

1. Surface monitored is within the transducer maximum range.
2. Transducer (P004) value matches the transducer used.
3. Transducer is located and aimed properly.

See the Transducer instructions for range, mounting, and rough aiming details.

For optimum performance, adjust transducer aiming to provide the best Echo Confidence (P805) for all material levels within the measurement range.

To display Echo Confidence in the RUN mode...



and hold for 4 seconds (Failsafe Time Left changes to the Short:Long Confidence display).

To display Echo Confidence in the program mode, access the Echo Confidence (P805) parameter. To update the value displayed after each aiming adjustment...



(5 times or more to verify stability)

If the condition persists (despite optimum aiming), optimize transducer performance. Adjust Short Shot Frequency, (P842) and Long Shot Frequency (P843) for maximum Echo Confidence (P805).

Increase the Failsafe Timer (P070) value, if failsafe operation will not be compromised by the larger value.

If "LOE" is displayed only when a sloped bottom vessel is near Empty, install an "target plate" in the bottom of the vessel. When exposed, the target plate provides the reflective surface representative of an empty vessel.

Install a longer range transducer, enter the new Empty (P006) distance, and (if necessary) optimize aiming and frequency again. If a longer range transducer is not available, connect an oscilloscope, (see Scope Displays, P810).

If an echo is observed (from the material/object surface), reduce the Confidence Threshold (P804) while taking new measurements (in the RUN or program mode).

If the surface cannot be detected during high vessel activity, set up Failsafe Operation to "anticipate" the material level change. This operation is reliable, as long as when the foam (or dust) settles a valid echo can be received. See **APPLICATIONS** Failsafe Operation.

FIXED READING

If the Reading is a fixed value, regardless of the transducer to material (object) surface distance, ensure the:

1. Transducer acoustic beam is free from obstruction.
2. Surface monitored is not within the transducers' nearest distance.
3. Transducer is not in contact with any metal object.
4. Material mixer (if used) is operating while the HYDRO+ is operating.

Check for (and remove if present) any acoustic beam obstruction.

If an obstruction cannot be removed or avoided, adjust the TVT (Time Varying Threshold) Curve to reduce the Echo Confidence derived from the sound reflected by the obstruction. (See Scope Displays, P810 and TVT Shaper, P832).

If the fixed Reading represents a distance within 2 metres (6 ft) from the transducer face, ensure the material (object) surface is not within the Transducers' *nearest distance*, (see **INSTALLATION** Transducer).

If the transducer is mounted on a standpipe, grind smooth any burrs or welds on the inside or *open end*, (the end that opens into the vessel). If the problem persists, install a larger diameter or shorter length standpipe, bevel the inside of the open end, or cut the open end of the standpipe at a 45 angle.

For "ST-series" transducers only, ensure non-metallic mounting hardware (supplied) is used. Often, loosening overtightened mounting hardware will mechanically isolate the transducer from a resonant metallic surface.

If difficulties persist, optimize transducer performance. Adjust Short Shot Frequency (P842) and Long Shot Frequency (P843) for maximum Echo Confidence (P805).

If the preceding remedies have not produced satisfactory results, the false echo has to be ignored. Extend Near Blanking (P800) to a distance (from the transducer face) to just beyond the distance represented by the Reading. This also increases the nearest distance the material level / object may come within the transducer face and still be detected.

If increasing Near Blanking is unacceptable (the transducer cannot be mounted higher) the TVT Curve must be raised in the area of the false echo.

Connect an oscilloscope to the HYDRO+, (see **PARAMETERS** Scope Displays, P810). Adjust the TVT Start Min (P833), TVT Start Duration (P834), and TVT Slope Min (P835) slightly.

Continue making minor TVT Curve adjustments and taking new measurements while observing the Echo Marker position until the Echo Lock Window repeatedly locks onto the true echo. Verify the false echo is still ignored, regardless of the vessel material level, or empty / fill activity.

WRONG READING

If the Reading is erratic, or jumps to some incorrect value periodically, ensure the:

1. Surface monitored, is not beyond the transducers maximum range.
2. Material is not falling into the transducer acoustic beam.
3. Material (P002) value matches the material monitored.
4. Measurement Response (P003) is not set too fast.
5. Transducer (P004) type entered matches the transducer used.

If a periodic wrong Reading is always the same value, see Fixed Reading. If the wrong Reading is random, ensure the material surface to transducer distance is less than the Empty value entered plus 20%. If the material/object monitored is outside this distance, increase Range Extension (P801) as required.

If the material monitored is a liquid, check for splashing in the vessel. Enter a lower Measurement Response (P003) value to stabilize the Reading, or install a stilling well. (Contact Milltronics or your local distributor).

If the Noise (P807) peak value jumps wildly, or average value is greater than +5 dB verify the transducer cable shields are connected to the HYDRO+ shield terminals and not to ground elsewhere.

If the HYDRO+ is mounted in close proximity to (or transducer cables run near those of) another ultrasonic level monitor, see Level System Sync (P726).

Temporarily disable nearby SCR control drives, high voltage or current contactors. If the condition disappears, move the HYDRO+ to another location.

Set Echo Lock (P711) to "max verification" (response to material level changes may be slowed somewhat).

Increase the Confidence Threshold (small amounts at a time) while observing the results. If performance is not improved return the Confidence Threshold to the preset value.

Connect an oscilloscope to the HYDRO+, (see **PARAMETERS** Scope Displays, P810). While monitoring the Echo Marker, select the Algorithm (P820) best suited to the material / conditions.

If the "Area" algorithm is used and narrow noise spikes are evident on the (long shot) Echo Profile, turn the Spike Filter (P821) on and/or widen the Narrow Echo Filter (P822). Also, if the true echo has jagged peaks, use Reform Echo (P823).

If multiple echoes appear on the Echo Profile, typical of a flat material profile (especially if the vessel top is domed), use the "first" Algorithm.

If the Echo Profile repeatedly switches from short to long, adjust the Short Shot Range (P852) to stabilize the "shot" mode used for the echo evaluation. Also, adjust the Short Shot Bias to increase (or decrease the amount of preference given to short shot echoes over long shot echoes).

Should a stable measurement still not be attainable, contact Milltronics or your local distributor.

SPECIFICATIONS

HYDRORANGER PLUS

- Power:
- » dc supply: » 9 - 30 V dc, 8 W, and / or
 - » ac supply » 100 / 115 / 200 / 230 V ac \pm 15%,
50 / 60 Hz, 15 VA
- Environmental:
- » location: » indoor / outdoor
 - » altitude: » 2000 m max
 - » ambient temp.: » - 20 to 50°C (- 5 to 122 °F)
 - » relative humidity: » wall mount: suitable for outdoor (Type 4X /
NEMA 4X / IP 65 enclosure)
» rack and panel mount: 80% for temperatures
up to 31 °C
 - » installation category: » II
 - » pollution degree: » wall mount: 4
» rack and panel mount: 2
- Range: » 0.3 m (1 ft) to 15 m (50 ft) max.
- Accuracy: » 0.25% of program range* or 6 mm (0.24"), whichever is greater
- Resolution: » 0.1% of program range* or 2 mm (0.08"), whichever is greater
- Memory: » EEPROM (non-volatile) no back-up battery required
- Programming: » via keypad programmer or Dolphin interface package
- Display:
- » Custom Graphics LCD
 - » wall mount: » 100 mm (3.9") W x 40 mm (1.6 ") H
 - » rack/panel mount: » 20 mm (0.8") W x 75 mm (3.0") H
- Temperature Compensation:
- » - 50 to 150 °C (- 58 to 302 °F)
 - » integral transducer sensor
 - » TS-3 temperature sensor
 - » programmable fixed temperature
- Temperature Error: » 0.09% of range with compensation
» 0.17% per °C deviation from programmed temperature

* Program range is defined as the empty distance from the face of the transducer (P006) plus any range extension (P801).

- Outputs:
- » transducer drive: » 150 to 315 V peak
(transducer model dependent)
 - » relays: » 5 alarm/control relays
 - » 1 form "C" SPDT contact per relay,
rated 5 A at 250 V ac, non-inductive
 - » all relays are certified for use in equipment where the short circuit capacity of the circuits in which they are connected is limited by fuses having ratings not exceeding the rating of the relays.
 - » mA output: » 0-20 or 4-20 mA, scalable
 - » 0.1% resolution
 - » 1K Ω max load
 - » communication » Dolphin Compatible via optional Milltronics ComVerter
- Input:
- » 0-20 or 4-20 mA, from alternate level monitoring device, scalable
- Enclosure:
- » wall mount: » Type 4X / NEMA 4X / IP 65
 - » 195 mm (7.7") W x 180 mm (7.1") H x 75 mm (3.0") D
 - » polypropylene alloy
 - » rack mount: » DIN 3U/14HP, 4 rail plug in unit
 - » suitable for standard 84 HP (19") sub rack
 - » panel mount: » suitable for DIN 43700 72 x 144 standard panel cut-out
- Weight:
- » wall mount: » 1.5 kg (3.4 lb)
 - » rack mount: » 870 g (1.9 lb)
 - » panel mount: » 1.1 Kg (2.4 lb)
- Approvals:
- » CE*, FM, CSA **NRTL/C**
 - * EMC performance available upon request
 - » wall mount: » CSA Class I, Div. 2, Group A, B, C, D
 - » CSA Class II, Div.2, Group G &F

Transducers

Compatible Models: » ST Ultrason[®], STH and Echomax[®] series
Refer to the associated instruction manual.

PROGRAMMER

- Power: » 9 V (ANSI / NEDA 1604, PP3 or equivalent) OR
» 3 V lithium battery
- Ambient Temp.: » -20 to 50°C (-5 to 122°F)
- Keypad: » 20 keys with tactile feedback
- Interface: » non-invasive, digital, infra-red
- Enclosure: » general purpose (waterproof) ABS plastic
» 67 mm W x 100 mm H x 25 mm D (2.6" W x 4" H x 1" D)
- Weight: » 150 g (0.3 lb)

OPTIONS

- Temperature Sensor: » TS-3
- Cable: » to suit transducers and TS-3's

Cable

- Transducer: » RG-62 A/U (or equivalent), 365 m (1,200 ft max)
- mA Output: » Belden 8760 shielded (or equivalent)
maximum separation 1,500 m (5,000 ft)
- mA Input: » Belden 8760 shielded (or equivalent)
maximum separation 1,500 m (5,000 ft)
- Synchronization: » no shielded cable necessary
- Relays: » no shielded cable necessary
- TS-3 Temperature Sensor: » cable, #LR29248-002 (Brite Red A69) HiTemp (or equivalent), 365 m (1,200 ft) per TS-3 maximum



PROGRAMMING CHART

| PARAMETER | | ALTERED VALUES FOR POINT NUMBERS | | | | |
|-----------|--------------------------|-----------------------------------|---|---|---|---|
| # | NAME | 1 | 2 | 3 | 4 | 5 |
| P000 | Lock (G) | | | | | |
| P001 | Operation (G) | | | | | |
| P002 | Material (G) | | | | | |
| P003 | Measurement Response (G) | | | | | |
| P004 | Transducer (G) | | | | | |
| P005 | Units (G) | | | | | |
| P006 | Empty | | | | | |
| P007 | Span | | | | | |
| P008 | Date (G) | | | | | |
| P009 | Time (G) | | | | | |
| P050 | Tank Shape | | | | | |
| P051 | Max Volume | | | | | |
| P052 | Tank Dimension A | | | | | |
| P053 | Tank Dimension L | | | | | |
| P054 | Level Breakpoints | record values on a separate sheet | | | | |
| P055 | Breakpoint Volumes | record values on a separate sheet | | | | |
| P060 | Decimal Position | | | | | |
| P061 | Convert Reading | | | | | |
| P062 | Offset Reading | | | | | |
| P070 | Failsafe Timer | | | | | |
| P071 | Failsafe Material Level | | | | | |
| P072 | Failsafe Level Advance | | | | | |
| P100 | Relay Setup (G) | | | | | |
| P110 | Relay Allocation | | | | | |
| P111 | Relay Function | | | | | |
| P112 | Relay A Setpoint | | | | | |
| P113 | Relay B Setpoint | | | | | |
| P114 | Relay C Setpoint | | | | | |
| P115 | Relay D Setpoint | | | | | |
| P116 | Bound Alarm Hysterisis | | | | | |
| P121 | Rate Pump (G) | | | | | |
| P122 | Pump Service Ratio | | | | | |
| P129 | Relay Failsafe | | | | | |

PROGRAMMING CHART

| PARAMETER | | ALTERED VALUES FOR POINT NUMBERS | | | | |
|-----------|----------------------------|----------------------------------|---|---|---|---|
| # | NAME | 1 | 2 | 3 | 4 | 5 |
| P130 | Run On Interval (G) | | | | | |
| P131 | Run On Duration (G) | | | | | |
| P132 | Start Delay (G) | | | | | |
| P133 | Power Resumption Delay (G) | | | | | |
| P134 | Pump Exercising | | | | | |
| P136 | Wall Cling Reduction (G) | | | | | |
| P137 | Pump Group | | | | | |
| P140 | Energy Saving (G) | | | | | |
| P141 | Peak Start Time (G) | | | | | |
| P142 | Peak End Time (G) | | | | | |
| P143 | Peak Lead Time (G) | | | | | |
| P144 | Peak A Setpoint | | | | | |
| P145 | Peak B Setpoint | | | | | |
| P146 | Time of Day Setpoint | | | | | |
| P150 | Storm A Setpoint | | | | | |
| P151 | Storm B Setpoint | | | | | |
| P152 | Storm Action | | | | | |
| P153 | Storm Max Duration | | | | | |
| P170 | Flush Pump | | | | | |
| P171 | Flush Interval | | | | | |
| P172 | Flush Cycles | | | | | |
| P173 | Flush Duration | | | | | |
| P180 | Rate Pump Reference | | | | | |
| P181 | Pump Rate Time | | | | | |
| P182 | Pump Rate | | | | | |
| P200 | mA Range | | | | | |
| P201 | mA Function | | | | | |
| P202 | mA Allocation | | | | | |
| P210 | 0 /4 mA Setpoint | | | | | |
| P211 | 20 mA Setpoint | | | | | |
| P212 | mA Min Limit | | | | | |
| P213 | mA Max Limit | | | | | |

PROGRAMMING CHART

| PARAMETER | | ALTERED VALUES FOR POINT NUMBERS | | | | |
|-----------|------------------------------------|-----------------------------------|---|---|---|---|
| # | NAME | 1 | 2 | 3 | 4 | 5 |
| P214 | 4 mA Trim | | | | | |
| P215 | 20 mA Trim | | | | | |
| P219 | mA Failsafe | | | | | |
| P250 | mA Input Range | | | | | |
| P251 | 0 /4 mA Input Setpoint | | | | | |
| P252 | 20 mA Input Setpoint | | | | | |
| P310 | Pump Hours | | | | | |
| P311 | Pump Starts | | | | | |
| P312 | Pump Run Ons | | | | | |
| P322 | LCD Total Low | | | | | |
| P323 | LCD Total High | | | | | |
| P330 | Profile Record | | | | | |
| P331 | Auto Record Enable (G) | | | | | |
| P332 | Auto Record Transducer (G) | | | | | |
| P333 | Auto Record Interval (G) | | | | | |
| P334 | Auto Record A Setpoint (G) | | | | | |
| P335 | Auto Record B Setpoint (G) | | | | | |
| P336 | Auto Record Filling / Emptying (G) | | | | | |
| P337 | Auto Record LOE Time (G) | | | | | |
| P340 | Date of Manufacture (V) | | | | | |
| P600 | Primary Measuring Device (G) | | | | | |
| P601 | Flow Exponent (G) | | | | | |
| P602 | Flume Dimension D (G) | | | | | |
| P603 | Max Head (G) | | | | | |
| P604 | Max Flow (G) | | | | | |
| P605 | Zero Head (G) | | | | | |
| P606 | Time Units (G) | | | | | |
| P607 | Flowrate Decimal (G) | | | | | |
| P608 | OCM Units (G) | | | | | |
| P610 | Head Breakpoints | record values on a separate sheet | | | | |
| P611 | Breakpoint Flowrates | record values on a separate sheet | | | | |
| P620 | Low Flow Cutoff (G) | | | | | |

PROGRAMMING CHART

| PARAMETER | | ALTERED VALUES FOR POINT NUMBERS | | | | |
|-----------|-----------------------------|----------------------------------|---|---|---|---|
| # | NAME | 1 | 2 | 3 | 4 | 5 |
| P621 | Auto Zero Head (G) | | | | | |
| P622 | Inflow Discharge Adjust (G) | | | | | |
| P623 | Pump Total Method | | | | | |
| P630 | LCD Total Factor (G) | | | | | |
| P633 | LCD Total Decimal (G) | | | | | |
| P640 | Remote Total Factor (G) | | | | | |
| P641 | Flow Sampler Mantissa (G) | | | | | |
| P642 | Flow Sampler Exponent (G) | | | | | |
| P645 | Relay On time | | | | | |
| P650 | Offset Calibration | | | | | |
| P651 | Sound Velocity Calibration | | | | | |
| P652 | Offset Correction | | | | | |
| P653 | Velocity | | | | | |
| P654 | Velocity @ 20 °C | | | | | |
| P660 | Temp Source | | | | | |
| P661 | Temp Fixed | | | | | |
| P663 | Temp Transducer Allocation | | | | | |
| P700 | Max Fill Rate | | | | | |
| P701 | Max Empty Rate | | | | | |
| P702 | Filling Indicator | | | | | |
| P703 | Emptying Indicator | | | | | |
| P704 | Rate Filler | | | | | |
| P705 | Rate Update Time | | | | | |
| P706 | Rate Update Distance | | | | | |
| P708 | Volume Rate Display | | | | | |
| P710 | Fuzz Filter | | | | | |
| P711 | Echo Lock | | | | | |
| P712 | Reserved | | | | | |
| P713 | Echo Lock Window | | | | | |
| P725 | Auxiliary Transducer | | | | | |
| P726 | Level System Sync (G) | | | | | |
| P727 | Scan Delay (G) | | | | | |
| P728 | Shot Delay | | | | | |

PROGRAMMING CHART

| PARAMETER | | ALTERED VALUES FOR POINT NUMBERS | | | | |
|-----------|---------------------------|-----------------------------------|---|---|---|---|
| # | NAME | 1 | 2 | 3 | 4 | 5 |
| P729 | Scan Time | | | | | |
| P730 | Auxiliary Reading (G) | | | | | |
| P731 | Auxiliary Reading Key (G) | | | | | |
| P732 | Display Delay (G) | | | | | |
| P733 | Scroll Access (G) | | | | | |
| P800 | Near Blanking | | | | | |
| P801 | Range Extension | | | | | |
| P802 | Submergence Transducer | | | | | |
| P803 | Shot / Pulse Mode | | | | | |
| P804 | Confidence Threshold | | | | | |
| P820 | Algorithm | | | | | |
| P821 | Spike Filter | | | | | |
| P822 | Narrow Echo Filter | | | | | |
| P823 | Reform Echo | | | | | |
| P825 | Echo Marker Trigger | | | | | |
| P830 | TVT Type | | | | | |
| P831 | TVT Shaper | | | | | |
| P832 | TVT Shaper Adjust | record values on a separate sheet | | | | |
| P833 | TVT Start Min | | | | | |
| P834 | TVT Start Slope | | | | | |
| P835 | TVT Slope Min | | | | | |
| P840 | Short Shot Number | | | | | |
| P841 | Long Shot Number | | | | | |
| P842 | Short Shot Frequency | | | | | |
| P843 | Long Shot Frequency | | | | | |
| P844 | Short Shot Width | | | | | |
| P845 | Long Shot Width | | | | | |
| P850 | Short Shot Bias | | | | | |
| P851 | Short Shot Floor | | | | | |
| P852 | Short Shot Range | | | | | |





www.siemens.com/processautomation

Siemens Milltronics Process Instruments Inc.
1954 Technology Drive, P.O. Box 4225
Peterborough, ON, Canada K9J 7B1
Tel: (705) 745-2431 Fax: (705) 741-0466
Email: techpubs.smpi@siemens.com

© Siemens Milltronics Process Instruments Inc. 2005
Subject to change without prior notice



Printed in Canada

Rev. 2.3